

Process Engineering

Innovative Solutions for Operators and Engineers





PROCESS ENGINEERING SOLUTIONS

Contents

WAGO-I/O-SYSTEM – One System for Every Application	4 – 5
JUMPFLEX® – The Standard for Signal Conditioners	6 – 7
Seven Steps to the Right Terminal Block	8 – 9
Disconnect/Test Terminal Blocks	10
High-Current, Rail-Mount Terminal Blocks for Conductors up to 185 mm ² (350 kcmil)	11
The WAGO Tool Chain	12 – 13
Explosion Protection	14 – 15
DIMA – Decentralized Intelligence for Modular Applications	16 – 17
Field Level Integration	18 – 19
Optimal System Topology through Flexible Interfaces	20 – 21
Wireless Communication	22 – 23

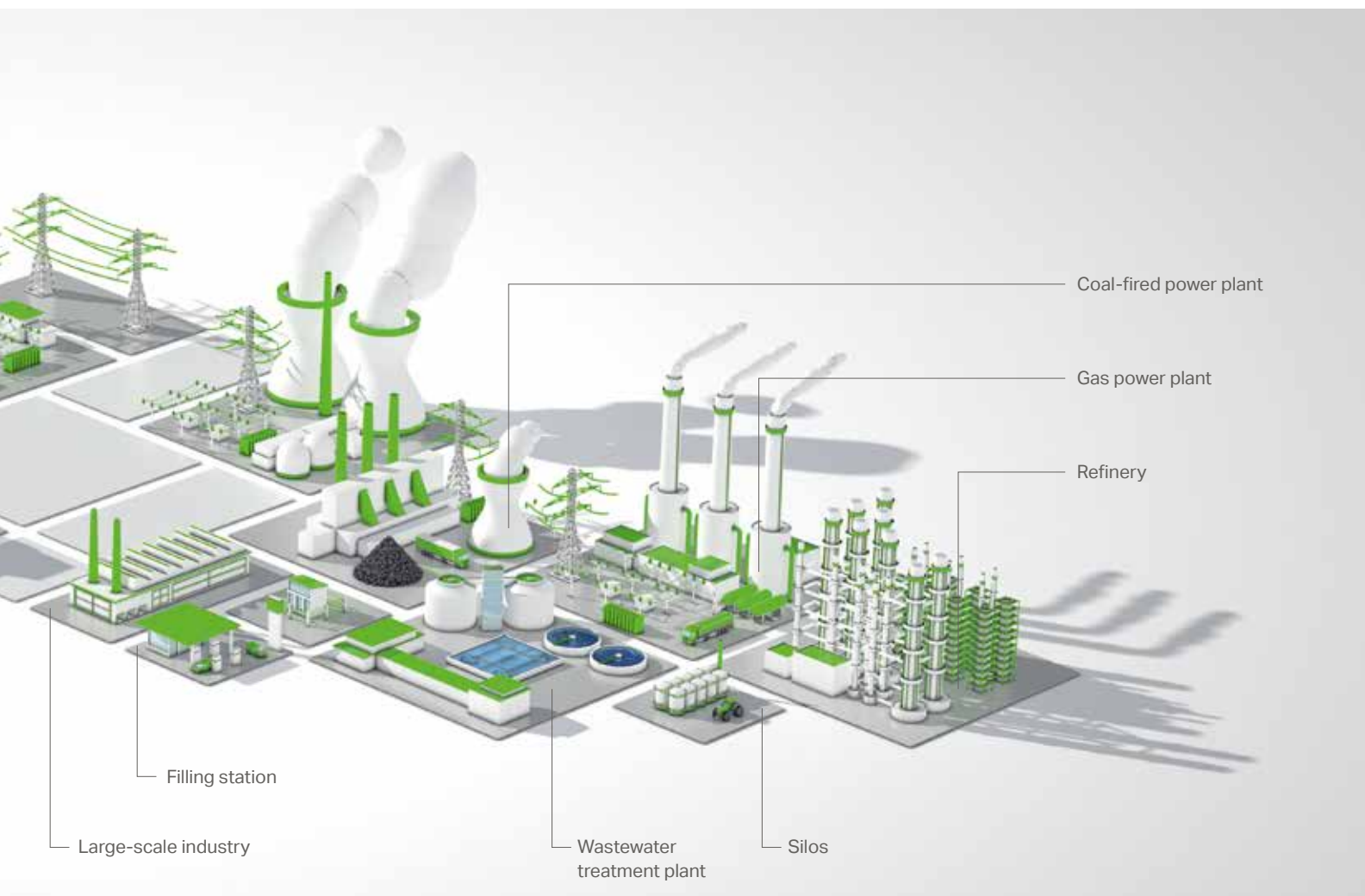

Manufacturer-Independent Networking of Subsystems	24
Telecontrol Gateway	25
Streamlining Pumps with Appropriate WAGO Solutions	26 – 27
Stay in Control	28 – 29
Patchboard and System Solutions	30 – 31
Monitor your Drives	32 – 33
Alarm and Monitoring Systems	34 – 35
Minimize Resource Consumption	36 – 37
Process Data Collection	38 – 39
Data Logger	40 – 41
Simply Convenient: Ready for MTConnect	42
Software	43
Configuring	44 – 45
System Macros	46 – 47
Quality Assurance	48 – 51

THE WAGO-I/O-SYSTEM

One System for Every Application

Maximum Fieldbus Independence

The system's modularity is also reflected in its support for numerous fieldbus systems and ETHERNET standards. Depending on the application, it is possible to choose between fieldbus couplers and communication modules for different protocols.

Worldwide Approvals

International approvals for building and industrial automation, as well as the process and marine industries, guarantee worldwide use – even under harsh operating conditions. These recognitions include: ATEX, BR-Ex, IECEx, UL508, UL ANSI/ISA and numerous marine certifications.

Maximum Flexibility

Each node in the WAGO-I/O-SYSTEM can be configured to meet every channel's requirements; various potentials and signal types are available (granularity of 1–16 channels). Digital and analog I/O modules, as well as specialty modules, can be freely mixed in the same node. Supply modules permit different voltages within the same node.

Extremely Compact

WAGO's patented mechanical design leads to extremely compact I/O nodes. In fact, select I/O modules can accommodate up to 16 channels in a 12 mm (1/2") wide housing. This provides the following advantages:

- Finely granular I/O modules for node customization
- Space-saving design permits high integration density and direct connection

Easy to Use

A modular, DIN-rail-mount design permits easy installation, expansion and modification of the I/O node. The straightforward design prevents installation errors. In addition, proven Push-in CAGE CLAMP® technology offers fast, vibration-proof and maintenance-free connections that are independent of operator skill. Depending on the I/O module's granularity, field peripherals can be directly wired using 1-, 2-, 3- or 4-wire technology.



Scalable Control Solutions

Interfaces are available for any size and type of automation task – from distributed I/O nodes or stand-alone control to global networks.

- Fieldbus couplers – standard for high I/O counts and economical for highly distributed applications
- Programmable controllers – for stand-alone, distributed or master control. Configuration, programming and visualization are performed via WAGO-I/O-PRO, WAGO's IEC 61131-3-compliant (CODESYS) software package.

Maximum Reliability and Ruggedness

The WAGO-I/O-SYSTEM is engineered and tested for use in the most demanding environmental conditions in accordance with the highest standards, e.g., those required in marine applications.

- Greatly increased vibration rating
- Significantly greater immunity to interference (ESD)
- Lower emission of interference
- Larger voltage fluctuation range
- Greater strength for continuous operation in upper temperature ranges

In addition, Push-in CAGE CLAMP® spring pressure connections ensure superior reliability. Integrated QA measures in the production process and 100 % function testing ensure consistent quality.

CODESYS as an Integrated Environment

All WAGO controllers are equipped with the high-performance CODESYS industry standard. This allows software development in IEC 61131-3 PLC programming languages (ST, FBD, LD, IL, SFC and CFC). As a trusted programming environment, CODESYS guides developers, allowing them to reuse and further develop existing programs without relearning software. This means that modern paradigms, such as Object-Oriented Programming (OOP), or modern visualization technologies are available.

Ex i Intrinsically Safe Modules

When used in hazardous areas of Zone 2/22, the WAGO-I/O-SYSTEM 750 offers a safe, easy and economical connection to the sensors and actuators of Zones 0/20 and 1/21. The "blue" Ex i I/O modules were specially developed for this purpose. They form an intrinsically safe section that can be integrated into a standard fieldbus node, offering all the advantages of a state-of-the-art fieldbus technology. The WAGO-I/O-SYSTEM 750 is also approved for mining applications.

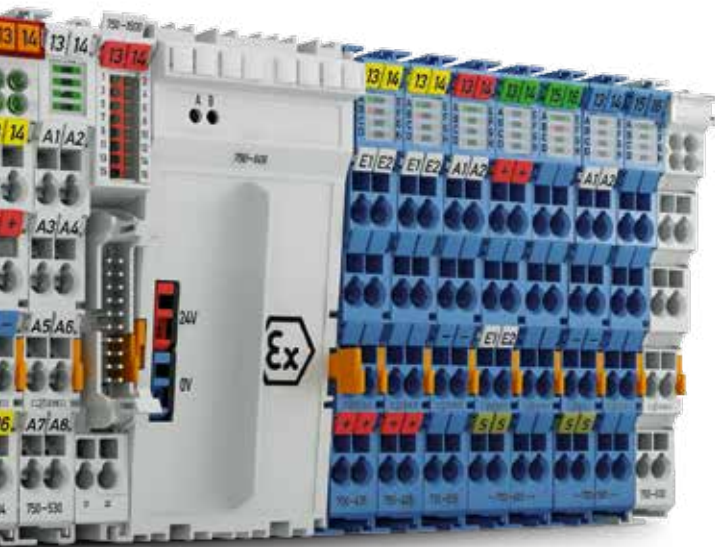

JUMPFLEX® – THE STANDARD FOR SIGNAL CONDITIONERS

857 and 2857 Series

For Extreme Temperatures

Support more applications via extended temperature range (857 Series: -25 °C ... +70 °C, 2857 Series: -40 °C ... +70 °C)

Maximum Safety

All devices provide "safe isolation" per DIN EN 61010-1

DIP Switches

Calibrated measurement range switching for input and output signals

Extensive Range of Marking Possibilities

Expedite control cabinet marking

The JUMPFLEX® Housing with a Built-In Power Supply

Common profile enables easy commoning of the output voltage

Configuration Display for Interface Modules

Configure, visualize and simulate process values via removable touch panel



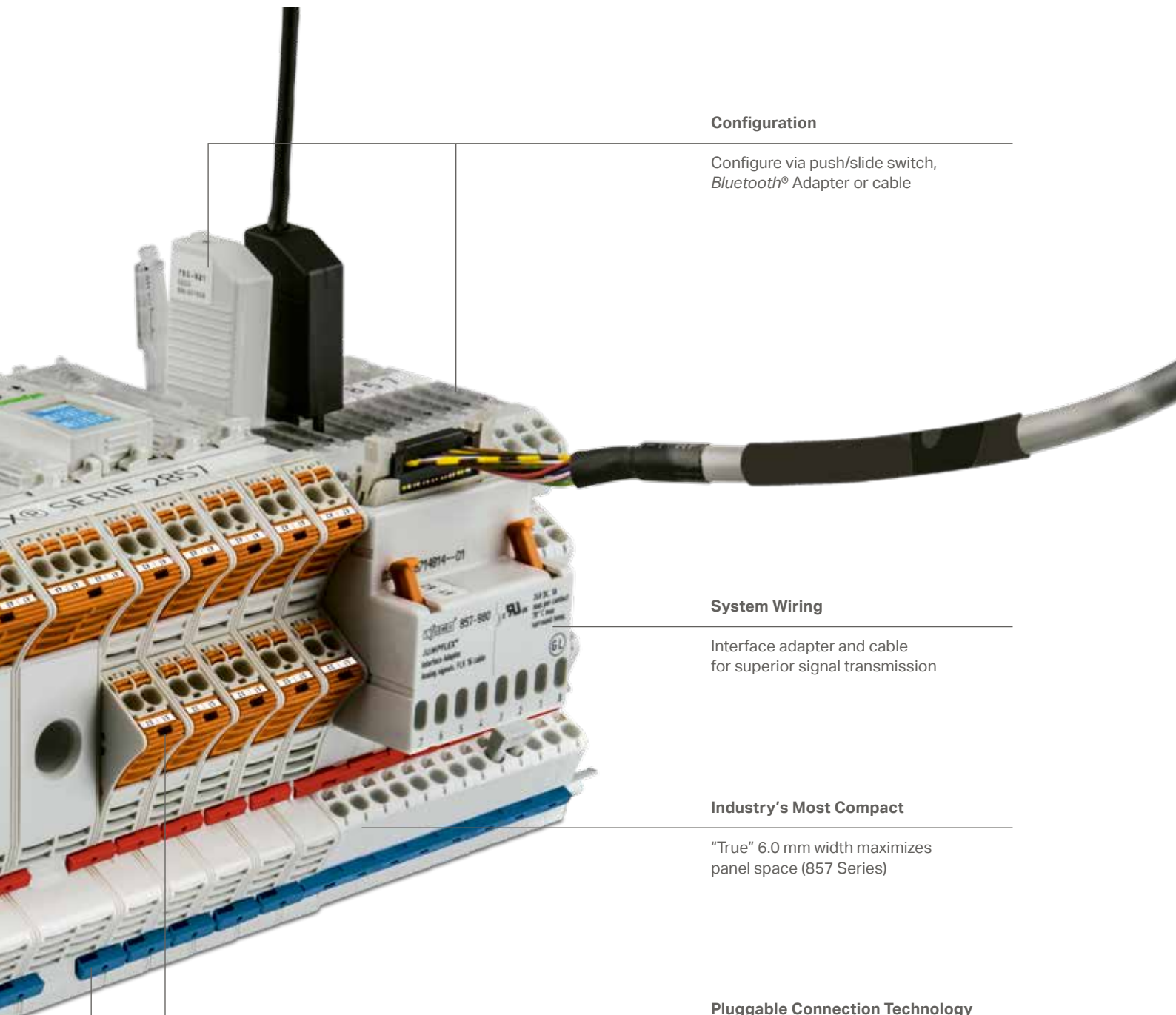

Configuration

Configure via push/slide switch, *Bluetooth*® Adapter or cable

System Wiring

Interface adapter and cable for superior signal transmission

Industry's Most Compact

"True" 6.0 mm width maximizes panel space (857 Series)

Pluggable Connection Technology

Provides convenient and cost-effective pre-installation wiring

Commoning, Not Discrete Wiring

Same profile allows the use of a single in-line, push-in jumper

CLEVER TERMINAL BLOCKS – PERFECT PROCESS

Seven Steps to the Right Terminal Block

Environmental conditions exist in the process industry that place extremely high demands on electrical connections. The questions you should ask when selecting rail-mounted terminal blocks and the answers you need about TOPJOB® S can be found here:

3 What must-have function should a terminal block offer?

Whether connecting a motor, diodes or LEDs, or if you need disconnect terminal blocks, TOPJOB® S Rail-Mounted Terminal blocks can meet virtually any need. The blocks are proven in measurement applications with a cross-section range from 0.14 mm² to 2.5 mm², and from 4 mm² to 25 mm² in a direct power supply. In addition, the product family includes through, double- and triple-deck terminal blocks. Your advantage: You only need one portfolio of rail-mounted terminal blocks for every application.

4 What is the terminal block's current capacity?

From the field level's smallest measurement signal to a load of 90 A within a power stack, TOPJOB® S Rail-Mounted Terminal Blocks exceed expectations when clamping connections with different nominal cross-sections. The rail-mounted terminal blocks can be wired using unprepared solid, stranded and fine-stranded conductors that are one size greater than their rated cross-section. Your advantage: Reduce wiring space and costs by up to 25 % compared to other terminal blocks.

2 What application will the terminal block be used for?

Whether subjected to a compressor's continual vibrations, salt fogs aboard a ship, oily air on an offshore platform or hazardous atmospheres in the chemical industry, TOPJOB® S Rail-Mounted Terminal Blocks have proven themselves in every field – even under the most extreme conditions. Your advantage: A safe connection in every environment, reducing your inventory and related expenses.

1 How will I connect the conductor?

In addition to push-in connection (see question 5), all conductor types can be connected using an operating tool. The tool remains in the operating slot – the clamping unit is marked and kept open, freeing the hands for wiring. The conductor entry is angled at 15 degrees relative to the operating tool for easier wiring.

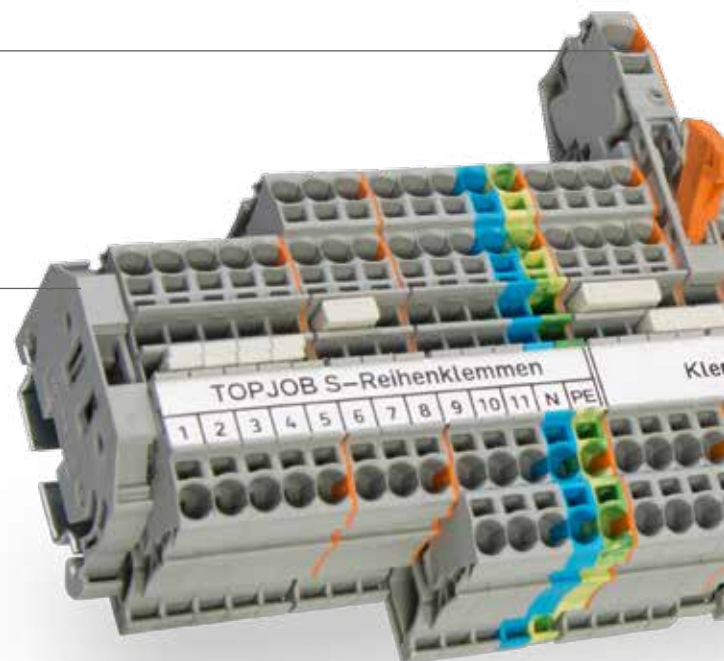

5 What conductor types will be connected?

With Push-in CAGE CLAMP®, the TOPJOB® S Rail-Mounted Terminal Blocks offer universal connections for all conductor types. TOPJOB® S Rail-Mounted Terminal Blocks reliably connect solid or stranded conductors, as well as fine-stranded conductors with or without ferrules. Your advantage: Directly connect fine-stranded conductors without ferrules, saving time and money.

6 How easy is it to mark a terminal block?

TOPJOB® S Rail-Mounted Terminal Blocks can be quickly and clearly labeled using continuous marking strips. Because the strips can be printed with three lines of information, there is space to designate each system module and its function. Your advantage: In one motion, you ensure wiring accuracy and save up to 75 % of your valuable time.

7 How do I make commoning as fast and flexible as possible?

A flexible jumper portfolio is available for TOPJOB® S: step-down, standard, continuous jumpers and colored jumpers. This even includes specialty solutions, like space-saving potential blocks, individual wire jumpers and push-in taps – everything in one rail-mounted terminal block family. Your advantage: A streamlined inventory with a universal portfolio.

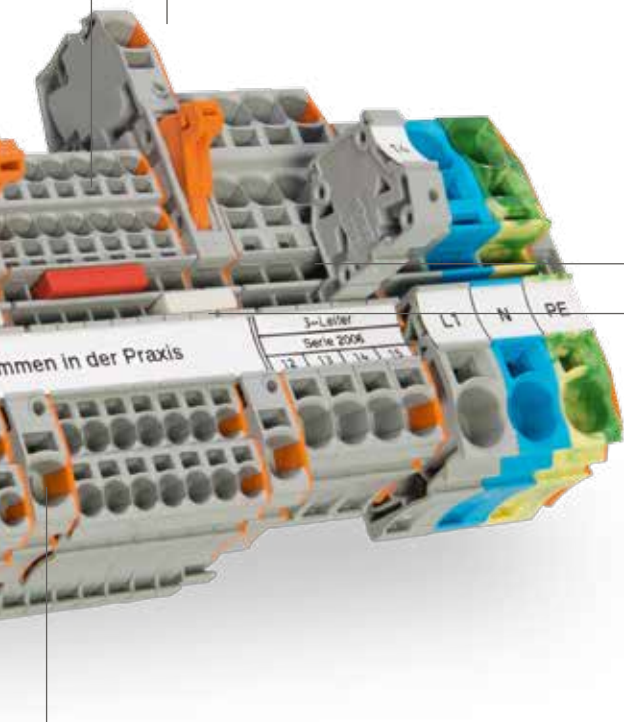

DISCONNECT/TEST TERMINAL BLOCKS

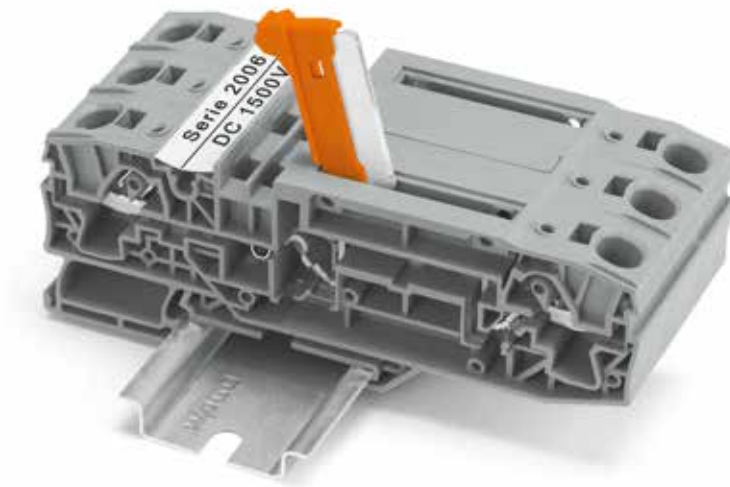

WAGO's 2006 Series TOPJOB® S Disconnect Terminal Blocks are designed for renewable energy applications (e.g., photovoltaic and wind power systems) where voltages exceeding 1,000 V (IEC) and 600 V (UL) are required (e.g., generator junction boxes).

Disconnect terminal blocks provide two alternative disconnect options: a disconnect plug or knife disconnect. These terminal blocks are approved for 1,500 VDC (IEC) or 1,000 VDC (UL) and 30 A.

With a terminal block width of 8 mm, the maximum cross-section for solid and fine-stranded conductors is 10 mm² (8 AWG) and 6 mm² (10 AWG) for ferruled conductors.

Key advantages:

- Two test ports are available per clamping unit
- Compatible with through terminal blocks of the same profile and all other TOPJOB® S terminal blocks

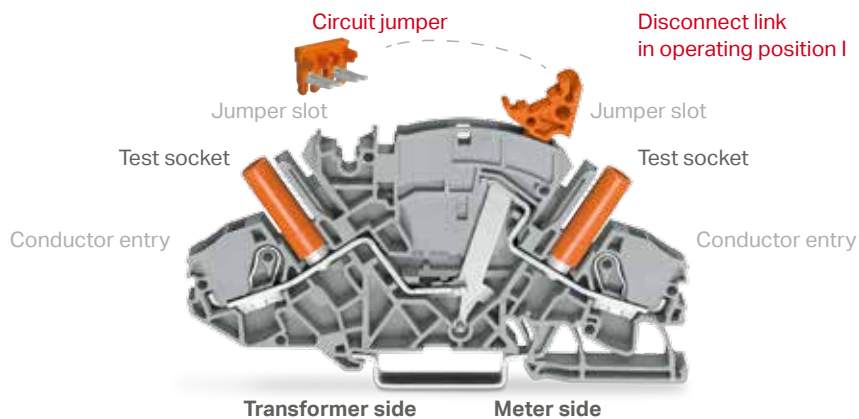

WAGO's TOPJOB® S Current Transformer (Disconnect/Test) Terminal Block (2007-8821) is designed for current transformer circuits.

First, the current transformer is shorted via disconnect link and circuit jumper (insert jumper, move disconnect link from operating position I to shorting position II, activate shorting path).

Connecting a measurement device via test socket on the meter side can only be performed once circuit disconnection is complete (disconnect link in measuring position III).

Features and benefits:

- Top-of-unit circuit jumper slot for shorting path activation
- Disconnect link provides intuitive and easy operation, as well as exact switching status indication

OUR POWER TEAM

High-Current, Rail-Mount Terminal Blocks for Conductors up to 185 mm² (350 kcmil)

The key to WAGO's success: springs, not screws. This design gives POWER CAGE CLAMP the appropriate clamping force for conductors up to 35, 50, 95 and 185 mm² (2, 2/0, 4/0 AWG and 350 kcmil).

Vibration-Proof – Fast – Maintenance-Free

Easy to Test

Easy troubleshooting via 4 mm Ø touch-proof test plug

Fast Termination

Eliminate time-consuming preparation – no ring terminals or ferrules required

Always Reliable

Optimum clamping force – independent of operator skill

Easy to Use

- Side conductor entry
- Orange locking tab keeps the clamp open, freeing the hands for wiring

Safe Commoning

- Easy and safe commoning via jumper system
- Safe and simple power tap (e.g., switch cabinet lighting, service socket)

Clear Marking

- Clearly visible labeling via marking strips
- Uses the WMB marking system



Perfect for Every Application

- The high-current terminal blocks meet the most stringent requirements, including those specified for pump units and engines.
- Heat- and cold-resistant – even under the heaviest of loads

The latest and largest member of our high-current family:

- 185 mm² connected via spring pressure
- 353 A
- Up to 1,000 VAC/DC
- Up to 1,500 VDC

smartDESIGNER

Planning

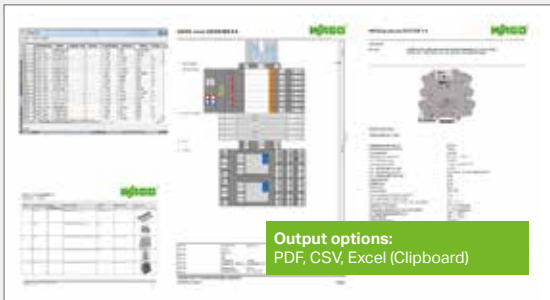

Export/Import

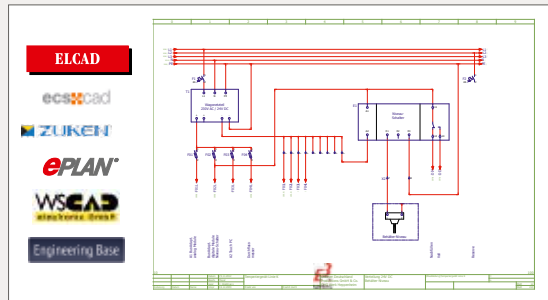

CAD Data Download



e!COCKPIT

Programming

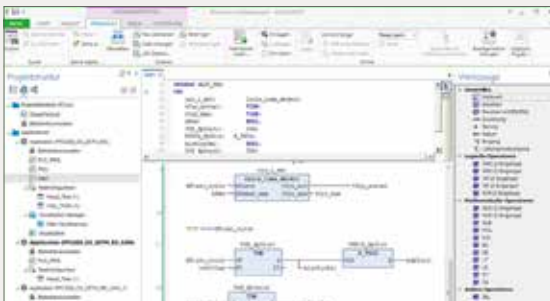

Visualization



Configuration



THE WAGO TOOL CHAIN

Full Support – From Planning to Commissioning

Timely engineering is essential for success in today's globally networked world. You must adapt to your customers' needs and demands in order to tap into new markets and outperform competitors. WAGO supports you in these efforts with an end-to-end tool chain.

smartDESIGNER accompanies you in every phase of control cabinet construction – with bidirectional interfaces to CAE systems, **smartPRINTER** and to WAGO's eShop. As a result, the management of master data and parts lists is performed at one single point.

e!COCKPIT invites you to discover: All project visualization from graphic network design up to the parameterization and diagnostics of the WAGO-I/O-SYSTEM 750, standard-compliant programming in CODESYS 3.5, modern visualization in HTML5.

Marking

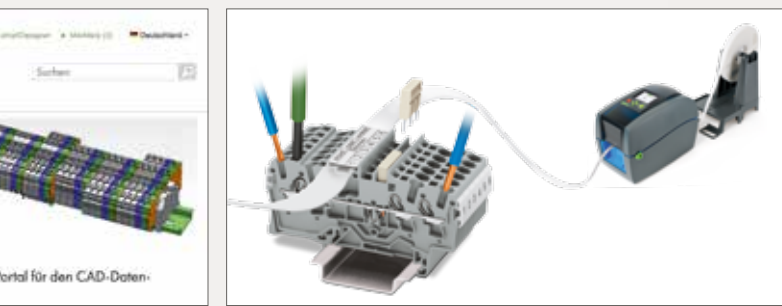

Diagnostics

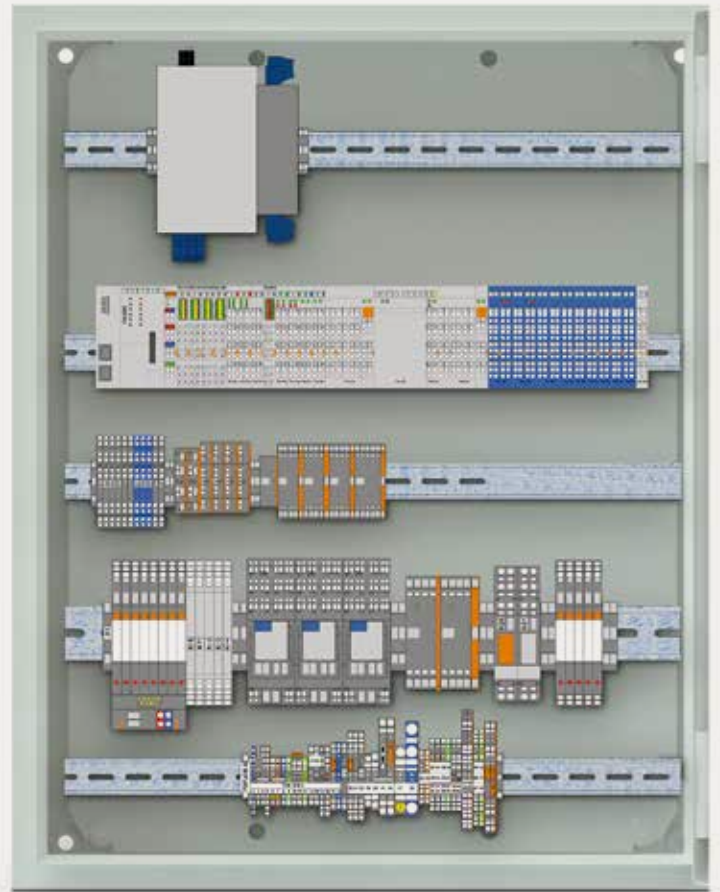

Continual Support

- *e!COCKPIT* for integrated engineering in automation
- *smartDESIGNER* for the life cycle of a control cabinet
- Seamless integration into CAE systems

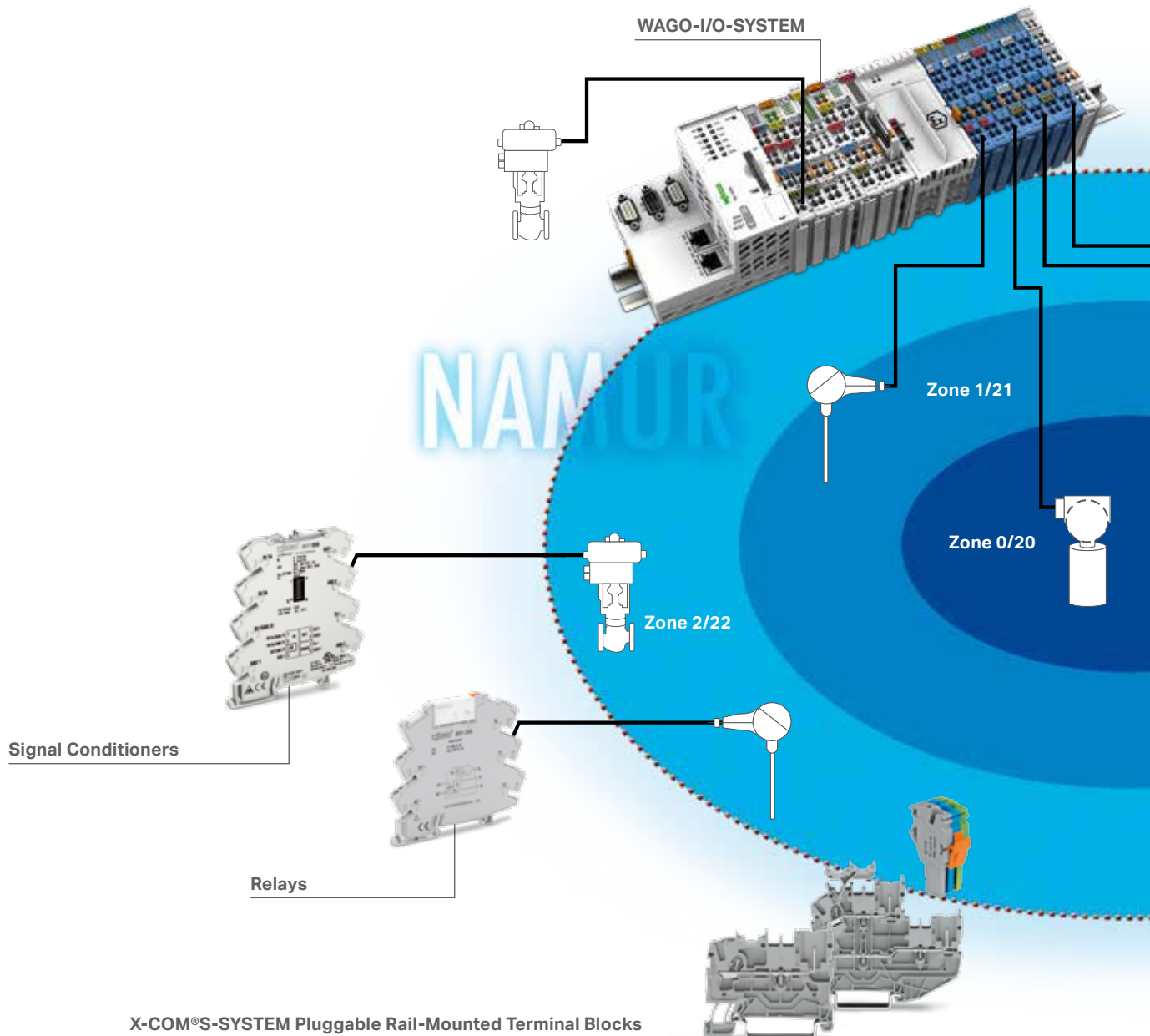

EXPLOSION PROTECTION – MADE BY WAGO

Don't Leave Anything to Chance

WAGO-I/O-SYSTEM 750

Whether offshore or onshore, above or below ground, in the refinery or producing pharmaceuticals and food – WAGO offers a universal system for your individual explosion-proof applications.

- Approved for use in Zone 2/22 (Device Category 3 G/D) and for underground mining as a device of Category M2
- Vibration-proof and maintenance-free thanks to proven CAGE CLAMP® Spring Pressure Connection Technology for worldwide applications via extensive approvals (e.g., ATEX, IECEx, ANSI/ISA, INMETRO)
- Easily integrate intrinsically safe signals from the field up to Zone 0 (Ex ia)
- Use intrinsically safe inputs with functional safety up to SIL 3, Cat. 4/ PL e PROFIsafe

Relays and JUMPFLEX® Signal Conditioners, 857 Series

When space is at a premium: Our relay modules and signal conditioners not only meet Device Category 3 G/D, they are also just 6 mm wide – ideal for revamping or retrofitting installations.

- Device Category 3 G/D (for use in Zone 2/22)
- Simple configuration via easy-to-use DIP switches
- Vibration-proof connections via WAGO Push-in CAGE CLAMP® technology
- Just 6 mm wide

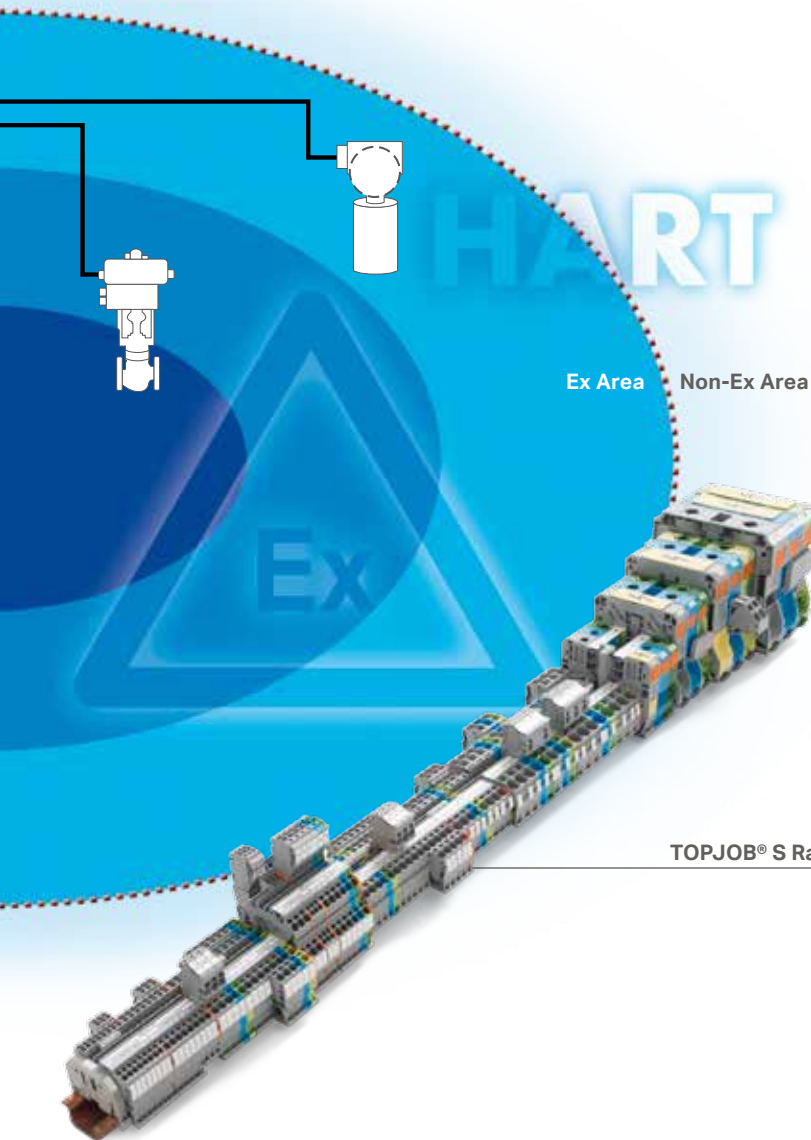

High-Current, Rail-Mounted Terminal Blocks

TOPJOB® S Rail-Mounted Terminal Blocks

TOPJOB® S and POWER CAGE CLAMP

Process engineering systems, such as pumps, compressors or drives are prone to both high- and low-frequency vibrations. Electrical connections are also often subjected to strong ambient temperature fluctuations. High contact resistance due to copper cold flow? Rely on WAGO's vibration-proof and maintenance-free rail-mounted terminal blocks to tackle real system challenges!

- Reliable connections from 0.14 to 185 mm² (24 AWG–350 kcmil)
- No need to retighten loose connections thanks to spring pressure connection technology
- Ex e I/II approval

X-COM®S-SYSTEM

Modularize systems and improve system uptime via fast and flexible maintenance solutions. This is made possible using the world's first pluggable rail-mounted terminal block system with Ex area approval.

Features and benefits:

- Pluggable and with all the advantages of our rail-mounted terminal blocks
- Locking lever also prevents accidental disconnection
- Ex nA approval for use in Zone 2/22



IEC 61511
EN IEC 62061
EN ISO 13849



Note:
www.wago.com/ex



DIMA – DECENTRALIZED INTELLIGENCE FOR MODULAR APPLICATIONS

Industry 4.0 in Process Control

Modular applications feature modules with different functions that are coupled to a backbone via docking station. The backbone supplies the modules (e.g., energy, raw materials, compressed air, data) and accommodates the control system (PLC) that supervises the entire system. Based on this system architecture, the production process can be easily adjusted to current requirements by varying the application modules; or the system output can be increased by simply parallelizing the modules. This solution allows manufacturers to quickly and flexibly react to changing market requirements.

This is the exact idea behind modular applications. However, the fact is that the challenge of modular systems is not in the physical modularization, but enabling an application's automation system to quickly modify or retrofit modules.

Until now, machinery and system manufacturers could not find a non-proprietary solution for automated integration of individual modules into a complete application. Therefore, the automation system of a modular application must laboriously be programmed by hand – this is extremely time consuming and prone to errors. With DIMA, WAGO proved for the first time how easily modular systems could be automated on a modular basis without extensive effort.



DIMA's Solution:

Large parts of the automation system's control intelligence are shifted from the process control system to the individual application modules. Similar to a printer driver that makes its services available to a computer, the individual application modules can provide their functions to the process control system via a Service Oriented Architecture (SOA). This process is not based on proprietary solutions, but on existing communication standards (e.g., OPC-UA). With the Module Type Package (MTP) that acts as a digital user manual, the application module provides all necessary information – which is required for its integration into the system and for its operation – to the process control system.

Result:

DIMA enables individual application modules with different functions to be integrated into a system via plug-and-play. This allows manufacturers to quickly and flexibly adapt their production processes to changing market requirements. This also allows engineering time to be shortened by a few days or even weeks, because the automation system no longer needs to be planned and programmed manually.

Discover the possibilities:
www.dima-process.com

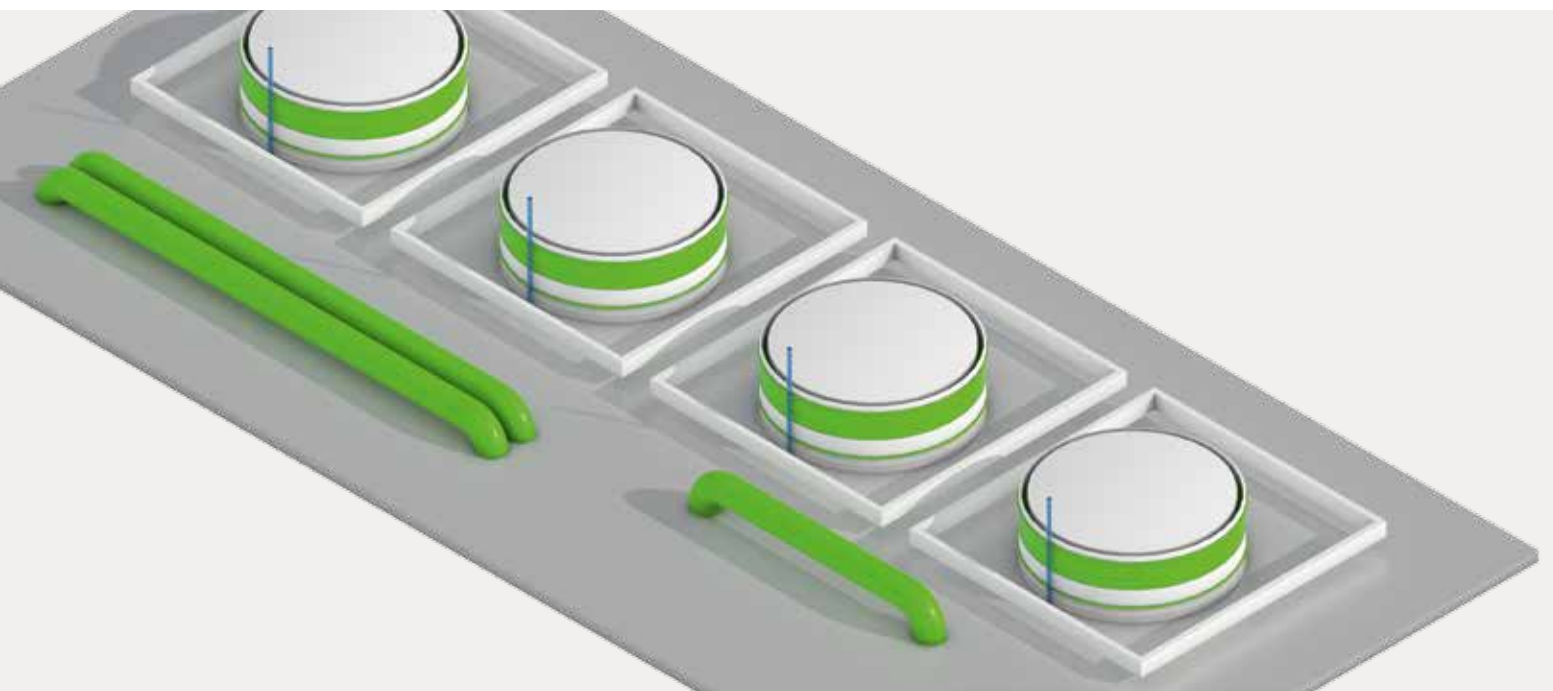

FIELD LEVEL INTEGRATION

Innovative Solutions for Connecting and Integrating Your Sensors and Actuators

Signal Splitting

Signal splitting is a simple and elegant solution to increase system uptime or transmit signals to a controller or data logger.

Signal Isolation/Conversion

The main reason for analog signal corruptions is potential differences that arise when the ground resistivity is growing due to increasing cable lengths. Signals with a ground reference are partly transmitted via the ground loop and misinterpreted. WAGO's Universal Isolation Amplifiers efficiently solve this problem by breaking up the ground loop for perfect signal transmission. They can also convert signals to the standard signal levels of the PLC's input cards (e.g., from 0 ... 10 V to 4 ... 20 mA).

Temperature Monitoring

A typical application is fermentation in breweries. Strict compliance with the limits of process variables ultimately determines product quality. Another example is a cooling system. Here the cooling system is controlled via switch points, allowing the temperature to be maintained at a constant level.

Limit Value Monitoring

Tank farms, pressure tanks or bulk material silos – protect your equipment via threshold value switches from the *JUMPFLEX*® family. Two-step controllers can be easily implemented via teach-in function of the threshold value switch without requiring a special controller. A separate output can also be set for the alarm indicating that the threshold value has been reached or requesting higher-level system evaluation.

Signal Splitting

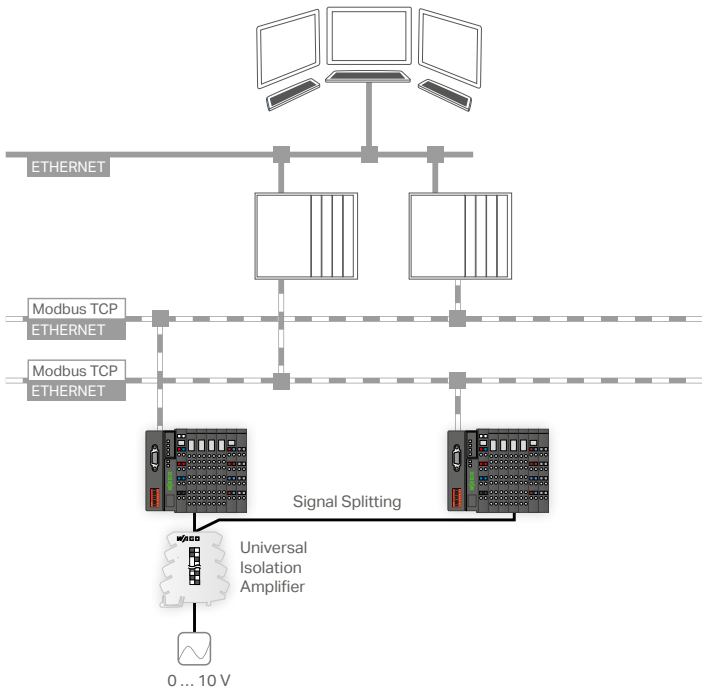

Temperature Monitoring

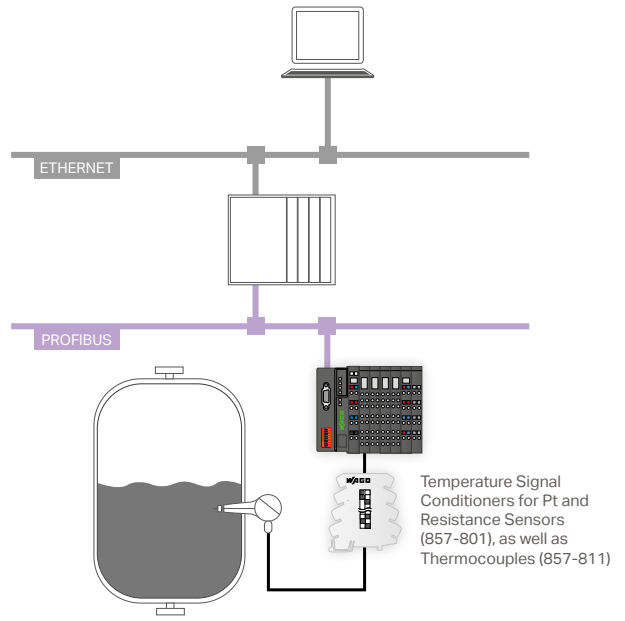

Signal Isolation/Conversion

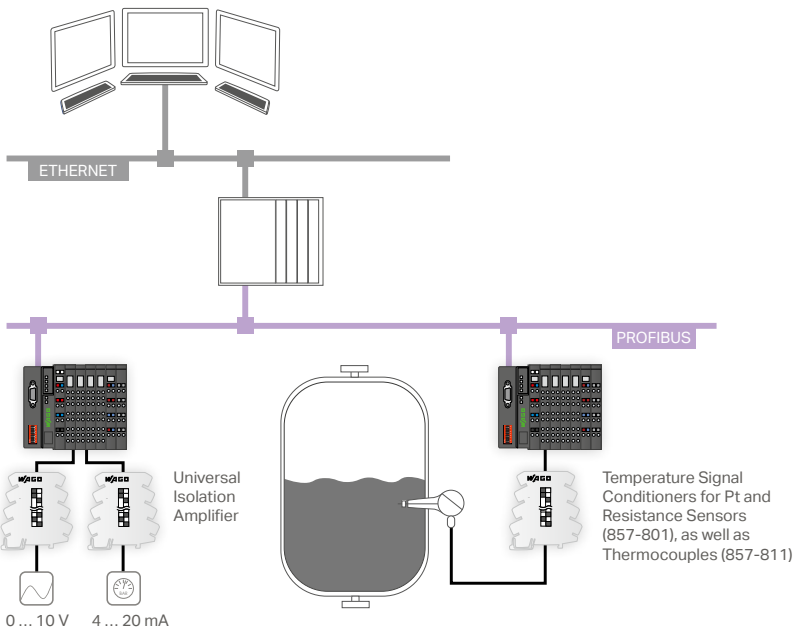

Threshold Monitoring

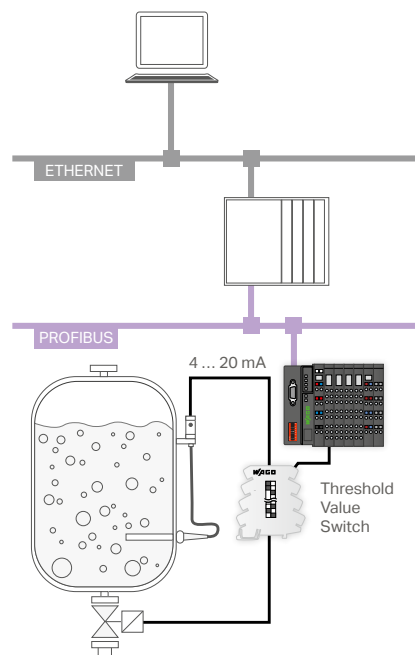

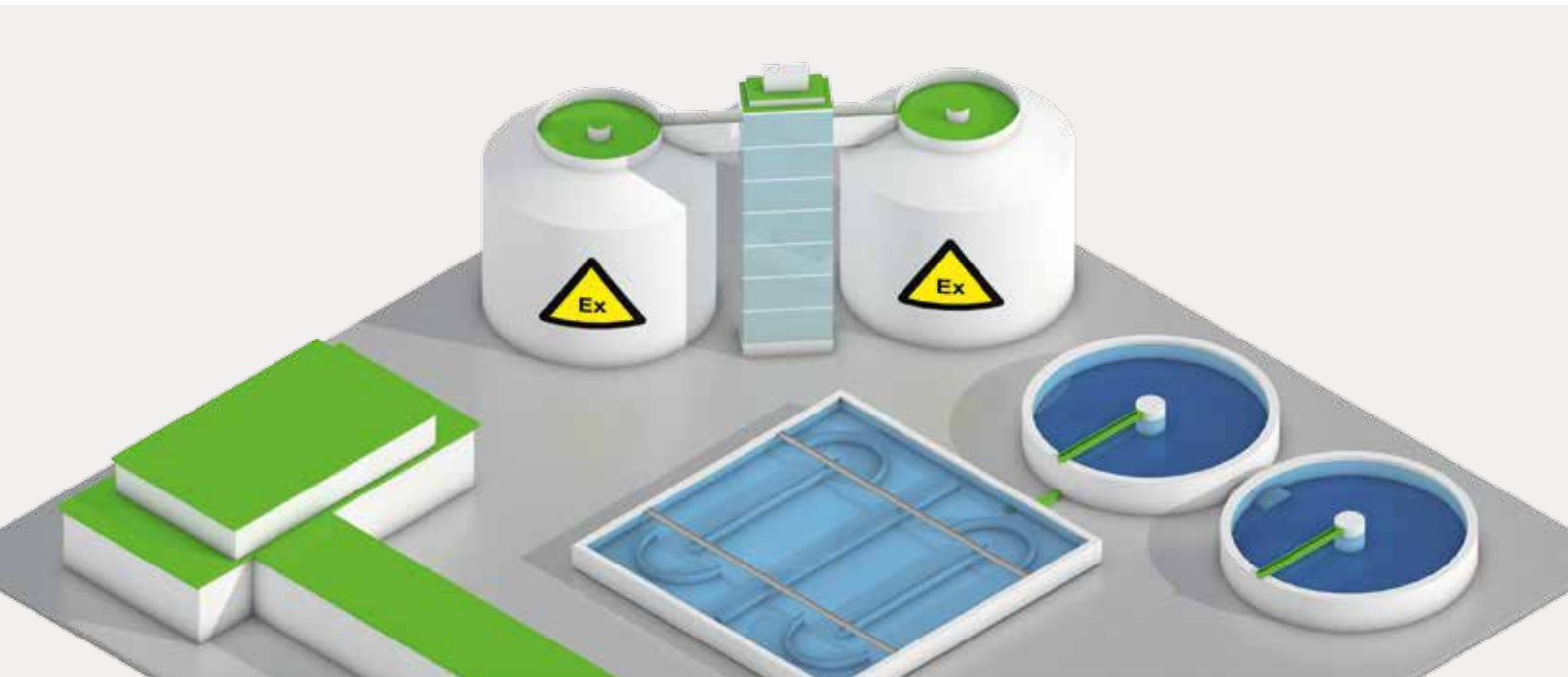

CLEAR AND WELL STRUCTURED

Optimal System Topology through Flexible Interfaces

Need a customized solution to integrate your subsystems into the control level? Our automation solutions provide you with multiple possibilities. Whether connecting remote pumping stations via GSM/GPRS communication, or transmitting data via industrial *Bluetooth*[®] connectivity, we have the right solution for your project!

Requirements for wastewater plant components:

- Robust system technology
- Performance in extreme environments
- System network applications
- Remote monitoring
- Ease of maintenance
- Highly flexible automation technology
- Support for standard fieldbus systems
- Control system connection
- Multiple interfaces
- Easily connect to sensors
- Use in hazardous locations

We are your complete automation partner – even for hazardous location applications:

- Approved for use in Zone 2/22 and mines
- Ex i I/O modules connect to intrinsically safe sensors/actuators
- Use anywhere in the world thanks to a comprehensive range of approvals (e.g., ATEX, IECEx, UL ANSI/ISA 12.12.01)

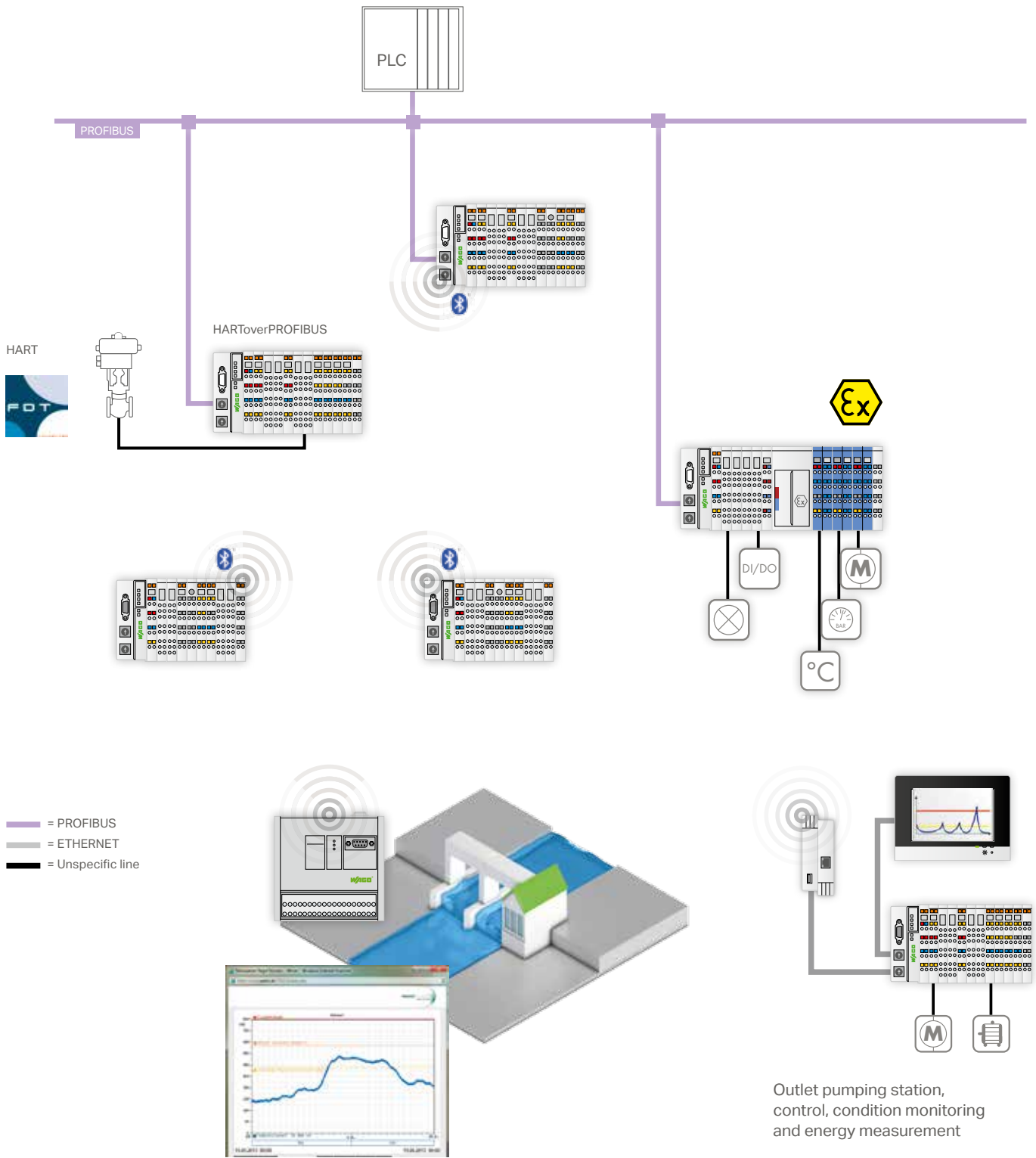

Level measurement via TO-PASS®
Compact GSM/GPRS communication

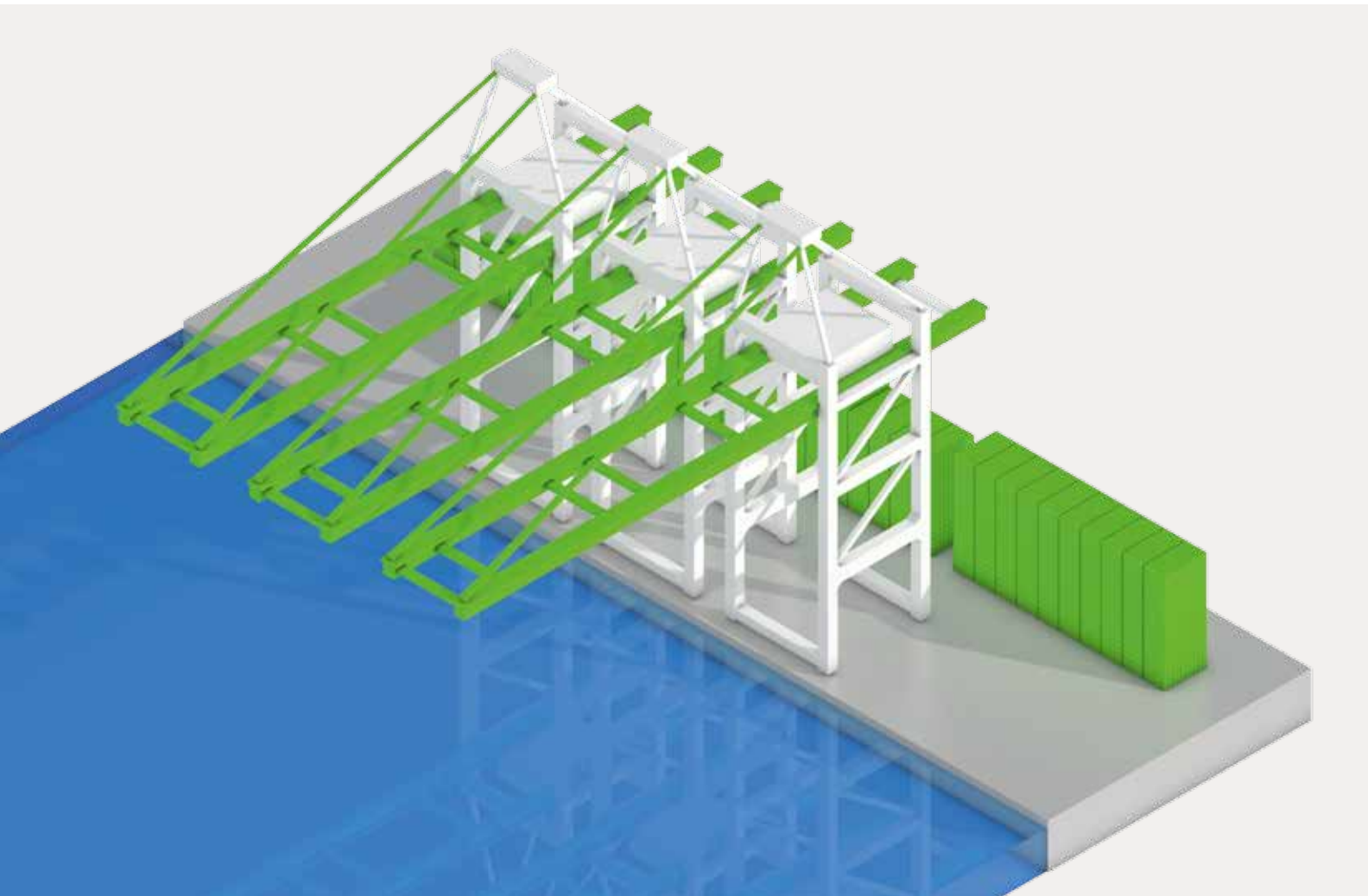

WIRELESS COMMUNICATION

- Secure networking in difficult-to-reach locations and over large distances
- Connect movable system parts (e.g., bridge scrapers or conveyors)
- Expand network structure between autonomous buildings
- All-in-one, custom control and wireless technology

Point-to-Point IP65 Communication

Range up to 400 m:

- Robust and maintenance-free cable substitute (IP65 protection and internal antenna)
- Easy configuration

Point-to-Point IP20 Communication

Range up to 1,000 m:

- Expand communication within the WAGO-I/O-SYSTEM
- Easy to use as multiplexer
- Optional fieldbus connection

Multipoint IP20 Communication

Range up to 1,000 m:

- Expand communication within the WAGO-I/O-SYSTEM
- Support up to eight devices in a single wireless network
- Create extensive networks
- Optional fieldbus connection
- Connect several stations within a wireless network

Point-to-Point IP65 Communication

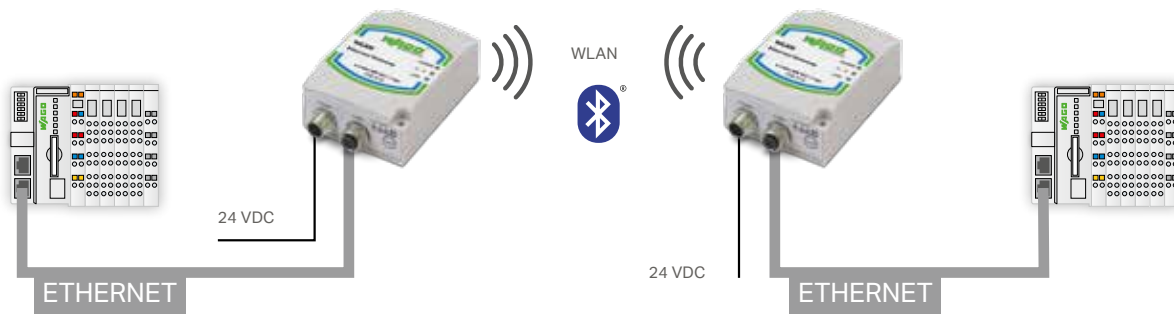

Point-to-Point IP20 Communication

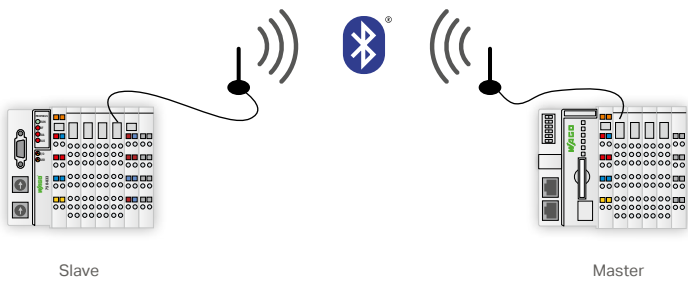

Multipoint IP20 Communication

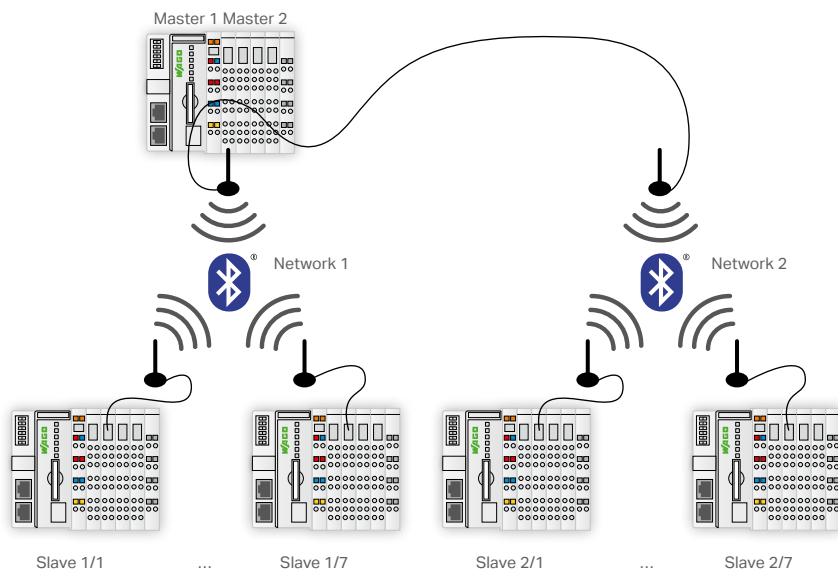

Advantages:

- Integrate different system components into a custom network
- Securely transmit data via *Bluetooth*[®], WLAN or GSM/GPRS
- Compact, wireless control solution

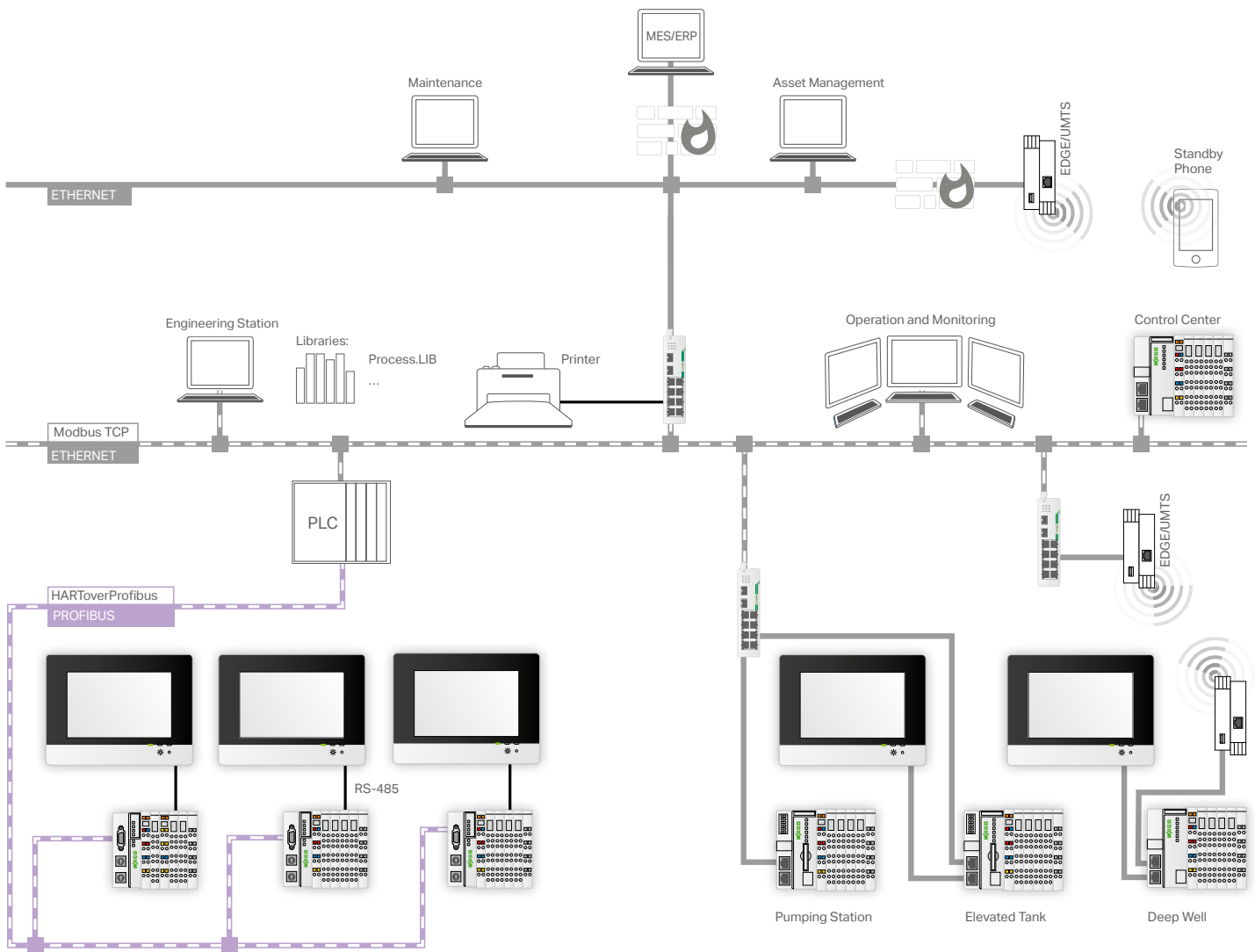

EXPAND THE POSSIBILITIES

Manufacturer-Independent Networking of Subsystems

Free yourself with our subsystem networking solutions that are tailored to your requirements. Benefit from our high-performance gateways with PLC functionality and easily connect telecontrol substations to our configurator via standardized telecontrol protocols:

- Integrate subsystems within the entire system network
- Universal connection possibilities for both measurement systems and substations
- Integrate various bus systems, such as ETHERNET, CANopen and PROFIBUS
- Communicate via different protocols: TCP/ IP; telecontrol protocols (IEC 6087-5-101/-103/-104); GSM/GPRS

Advantages:

- Individual integration into the network structure via select WAGO Controllers
- High-performance gateways with PLC functionality
- Support standard fieldbus systems (e.g., PROFINET, PROFIBUS, CANopen)
- Communicate via telecontrol protocols per IEC 60870-5-101/-103/-104; IEC 61850; DNP 3



Control Level

Transmission Level

Field Level

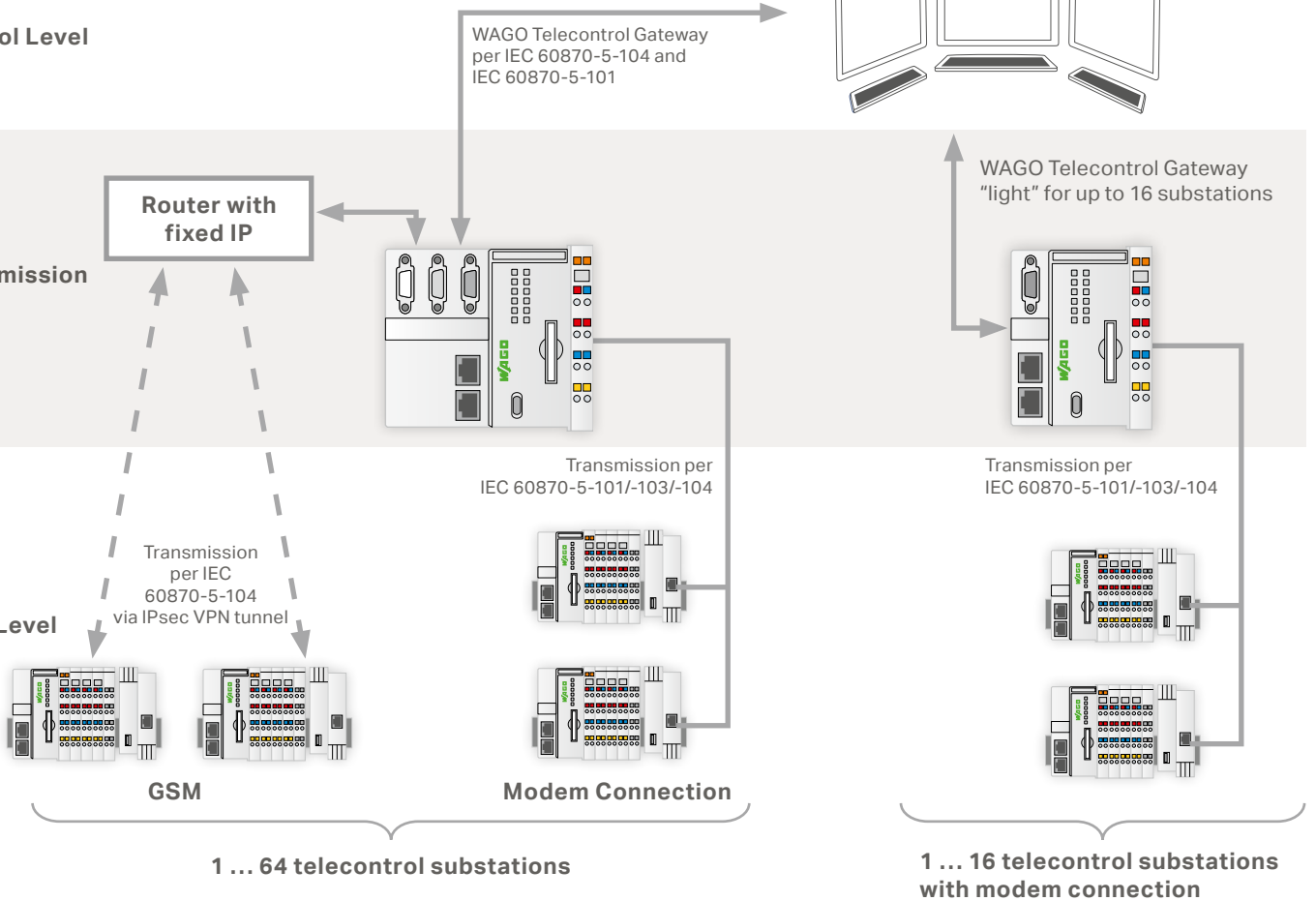

Telecontrol Gateway

The WAGO Telecontrol Gateway makes it easy to connect several substations with up to two redundant control systems. Furthermore, simple parameterization is provided using our Web-Based Management.

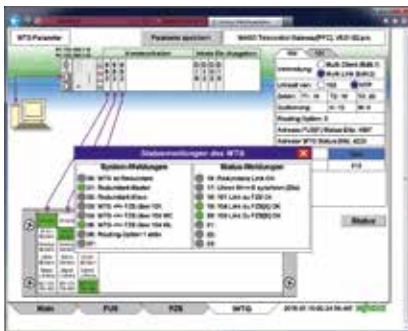

Web-Based Management (WBM)

Advantages:

- Communicate per IEC 60870-5-101/-103/-104
- Connect to a substation via GSM, dedicated or dial-up line
- No control system limiting the number of connections
- Easy parameterization via Web-Based Management
- Transmitted data requires no parameterization
- Optional redundancy operation
- Can be used as a protocol converter

IEC 60870-5-101/-103/-104,
61850, 61400
DNP3



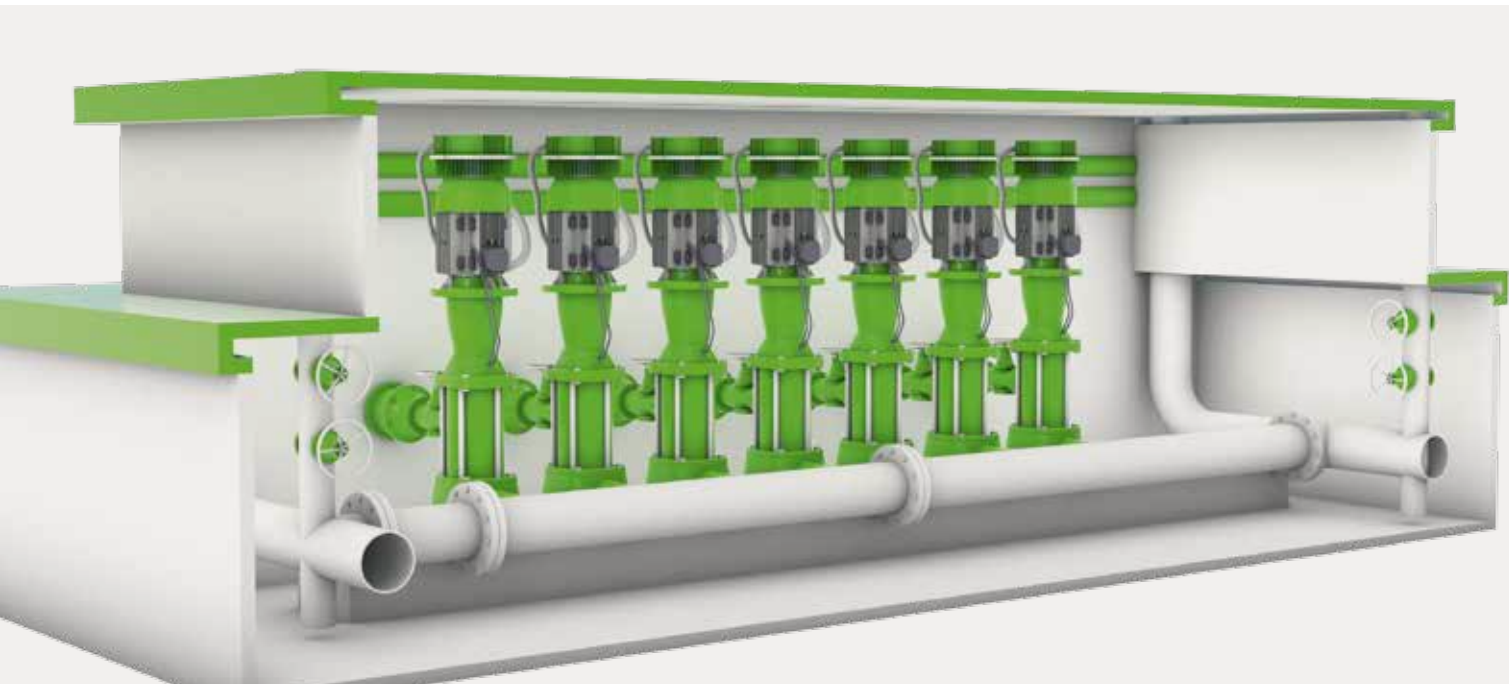

THE HEART OF THE PROCESS INDUSTRY

Streamlining Pumps with the Right WAGO Solutions

Pumping stations are an essential part of industrial process infrastructures. System reliability depends on two main factors: maintenance and monitoring. In fact, both a pump's operating point and drive monitoring, as well as the monitoring of both ambient and process parameters (e.g., temperature, pressure, flow rate and bearing condition) are essential for preventive maintenance. Equally important is the reliability and resilience of the monitoring systems.

With its high-performance controllers, WAGO offers you a solid foundation for controlling and monitoring pump systems, as well as preventive maintenance.

With *EPSITRON*[®], we also provide your controllers with a reliable power supply solution, including both UPS and redundancy units. WAGO enables you to keep an eye on the heart of your system.

Advantages:

- AI modules for pressure, 4 ... 20 mA, differential pressure, temperature, flow rate (also intrinsically safe)
- PTC modules for winding temperature monitoring
- Module for bearing vibration monitoring
- 3-phase power measurement modules for power output monitoring and for the energy management system

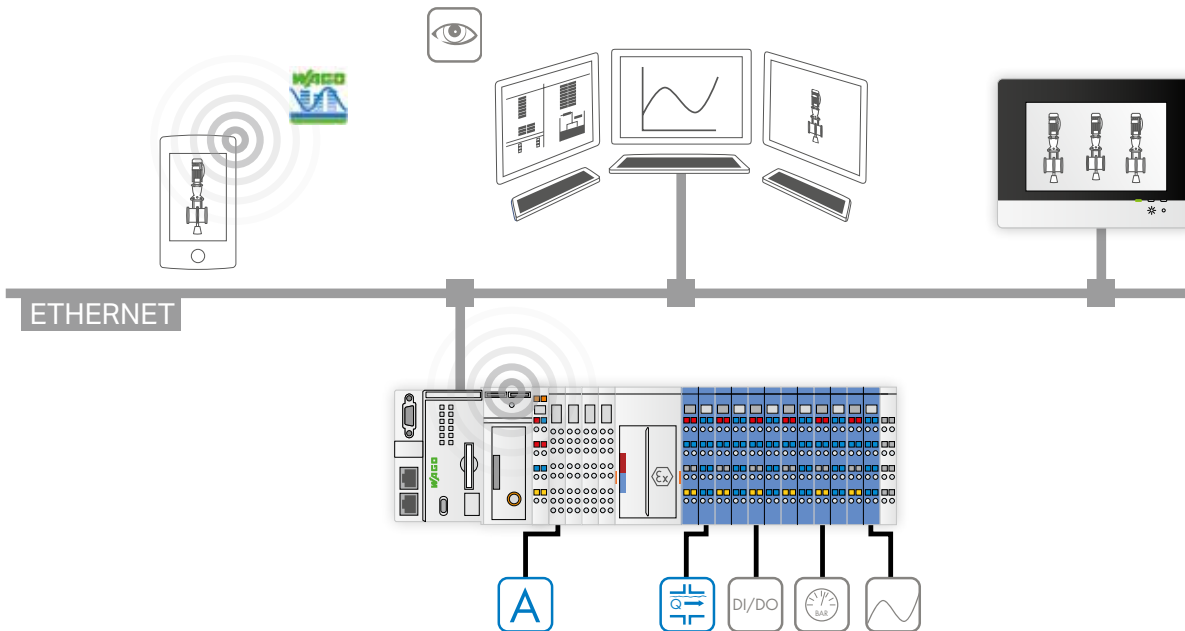

PROGRAMMING

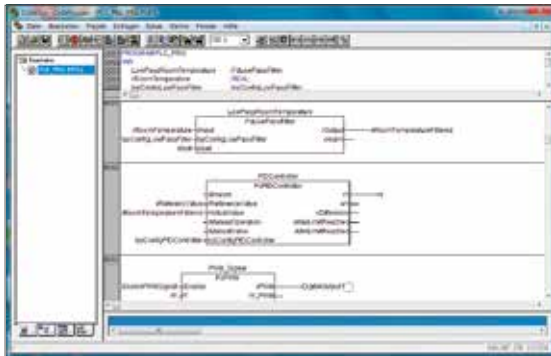

Application notes with numerous examples and ready-made function blocks reduce the time required for programming a preventive maintenance solution.

VISUALIZING

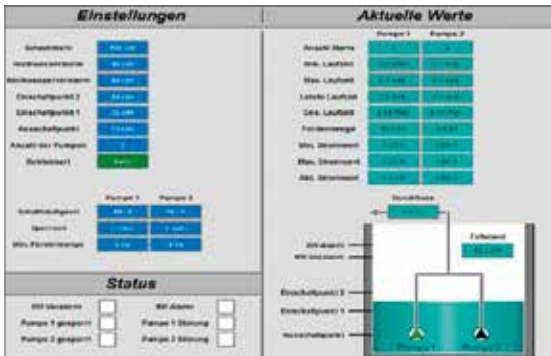

Ready-made visualization masks (e.g., alternating pump control or threshold monitoring) simplify both system operation and monitoring.

EVALUATION



Whether it's our WAGO-I/O-CHECK commissioning tool or ready-made CODESYS programs for evaluation and preventive maintenance, we can offer you a tailor-made solution.

Please feel free to contact us for more detailed information:
process@wago.com

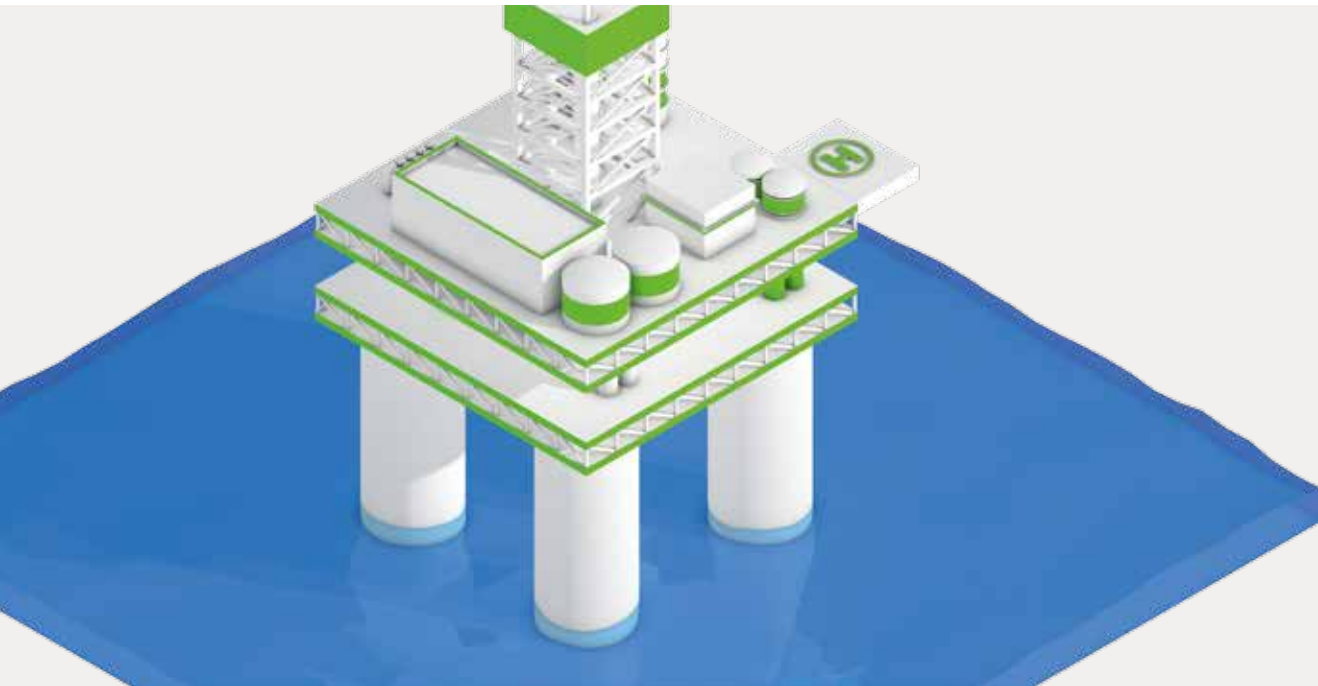

STAY IN CONTROL

Easily Configure Your Proportional Valves

Requirements:

Extremely fast and easy maintenance/parameterization of systems and components is essential for the safe operation of remote facilities, such as offshore drilling and production platforms. This also applies to a drilling rig's hydraulic systems, including the iron roughneck, top drive and draw-work installations.

WAGO's Proportional Valve Module (750-632) allows you to easily control both hydraulic and pneumatic proportional valves.

Advantages:

- Flexible and convenient proportional valves control
- Precise current control
- Easy scaling and valve adjustment
- Simple configuration and parameterization via **WAGO-I/O-CHECK**
- Up to 2 A output current

Operating Modes:

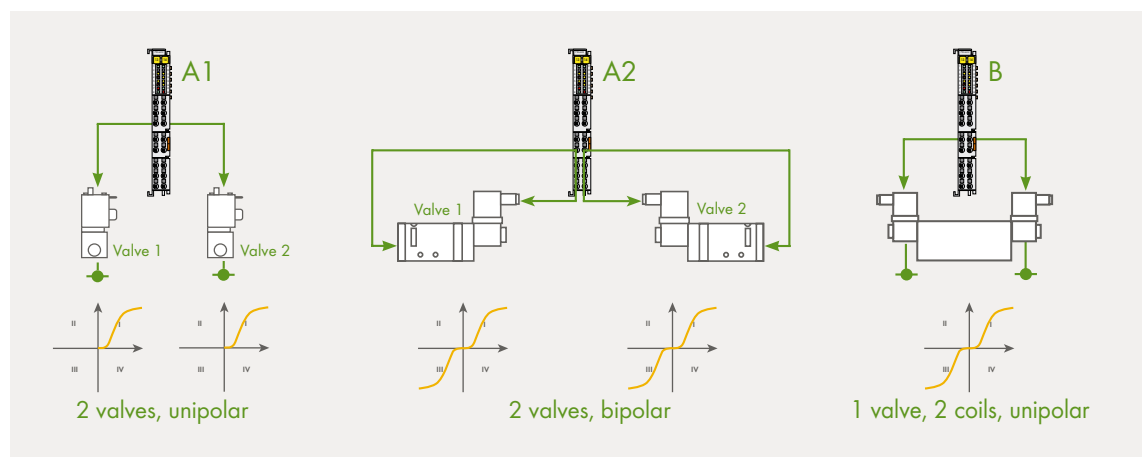

Dithering

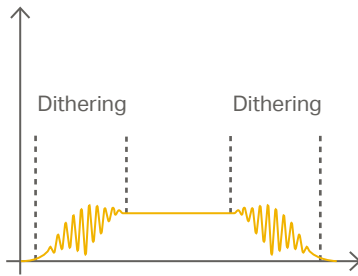

Valve Adjustment

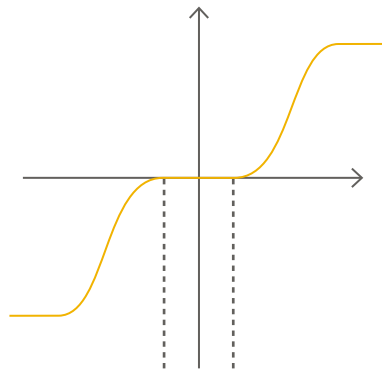

Setpoint Ramps

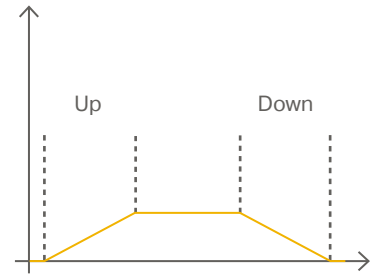



Dithering and Valve Adjustment Keeps You under Control

To perform current control, WAGO's Proportional Valve Module features two pulse-width-modulated 24 V outputs (PWM) with adjustable dither. Discrete dither frequency adjustment minimizes the motion, which is adjusted to the valve around the rest position. This allows the set point to be defined without considering static friction.

- Dual gain compensation is also included.
- Characteristic curve adaptations, such as zero offset, dual gain compensation or range limitations, can be adjusted via parameters.
- Two additional configurable digital inputs connect directly to sensors or switches, e.g., for end position monitoring.



Module Features:

- Proportional control of hydraulic or pneumatic valves
- Two current-controlled PWM outputs
- Two operating modes:
 - 2 channels with 1.6 A
 - 1 channel with 2.0 A
- Two additional digital function inputs
- Switchable dithering
- Adjustable setpoint ramps
- Valve adjustment:
 - Dual gain compensation
 - Scaling
 - Linearization
- Approvals:
 - CE conformity marking
 -  508
 -  ANSI/ISA 12.12.01
 - Marine applications (GL)



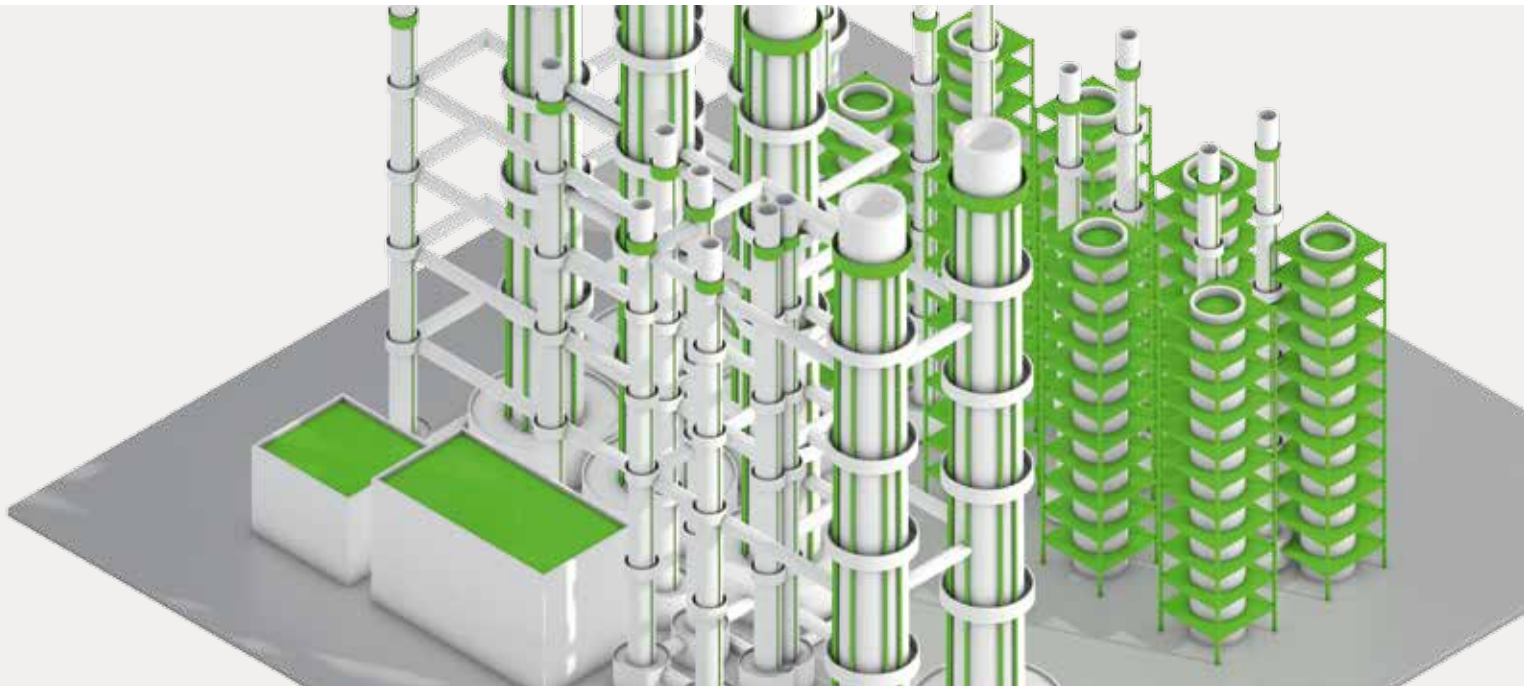

IT ALL DEPENDS ON THE CONNECTION

Patchboard and System Solutions to Connect Your Control System

When it comes to patching signals with high-density wiring, our matrix patchboards and terminal blocks for matrix patching are the space-saving solution for connecting the process control level to field-level sensors. Clear and well structured – always in control and quickly accessible!

- Connect the process control level to field-level sensors
- Matrix patching solutions for space-restricted applications
- Clear and well structured matrix patchboards
- Quicker recommissioning thanks to streamlined maintenance
- Easy access for safe measurement during maintenance

Reliable matrix patching and high-density wiring via WAGO Matrix Patchboards with CAGE CLAMP® Connection.

- Available as 32-, 48-, 62-, 80-pole matrix patchboards in a 19" rack
- Slimline design for 19" racks
- Matrix patchboards for Ex i applications
- Integrated test sockets for each signal/potential
- Common potential matrix patchboards
- Individual group marking of the matrix patchboard
- Factory-marked channels
- Easy group marking

Advantages:

- **Save valuable cabinet space**
- **Simple operation via screwdriver – no specialty tool required**
- **High signal density**
- **Maximum Flexibility**
- **Marking each clamping point enhances clarity**
- **Maximum measurement safety compared to outdated solder and wire-wrap solutions**
- **Suitable for Ex i applications**
- **Maximize time savings via pluggable modules when upgrading your installation**

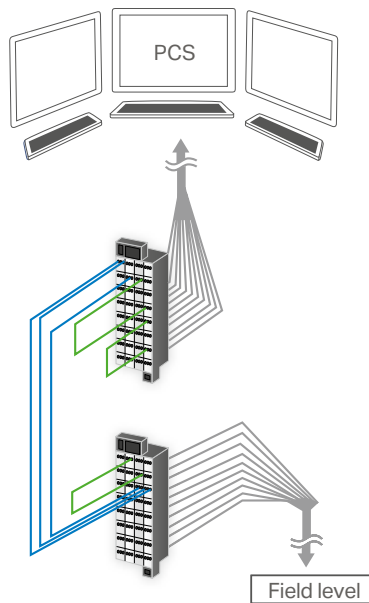
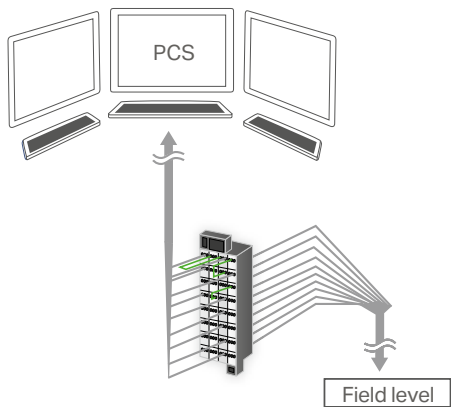

Upgrade Your Installation via Pluggable and Quickly Replaceable Modules



Terminal Blocks for Matrix Patching, 726 Series

- Reliable matrix patching for high-density wiring: WAGO matrix patchboards with CAGE CLAMP® connection.
- Colored module assemblies provide a better overview
 - Individual group marking of the matrix patchboard
 - Factory-marked modules
 - Combine several patchboards into a group with an additional group marking carrier



Terminal Blocks for Matrix Patching, 727 Series

- Customize your matrix patching application via individual terminal block arrangement
- Clear connection layout via cable duct holder
- Easy-to-read labeling via factory marking
- Group marking provides a better overview



Pluggable Interface Modules, 289 Series

- Easy installation via pluggable modules
- Minimize downtime via main cable assemblies
- For 19" rack mounting

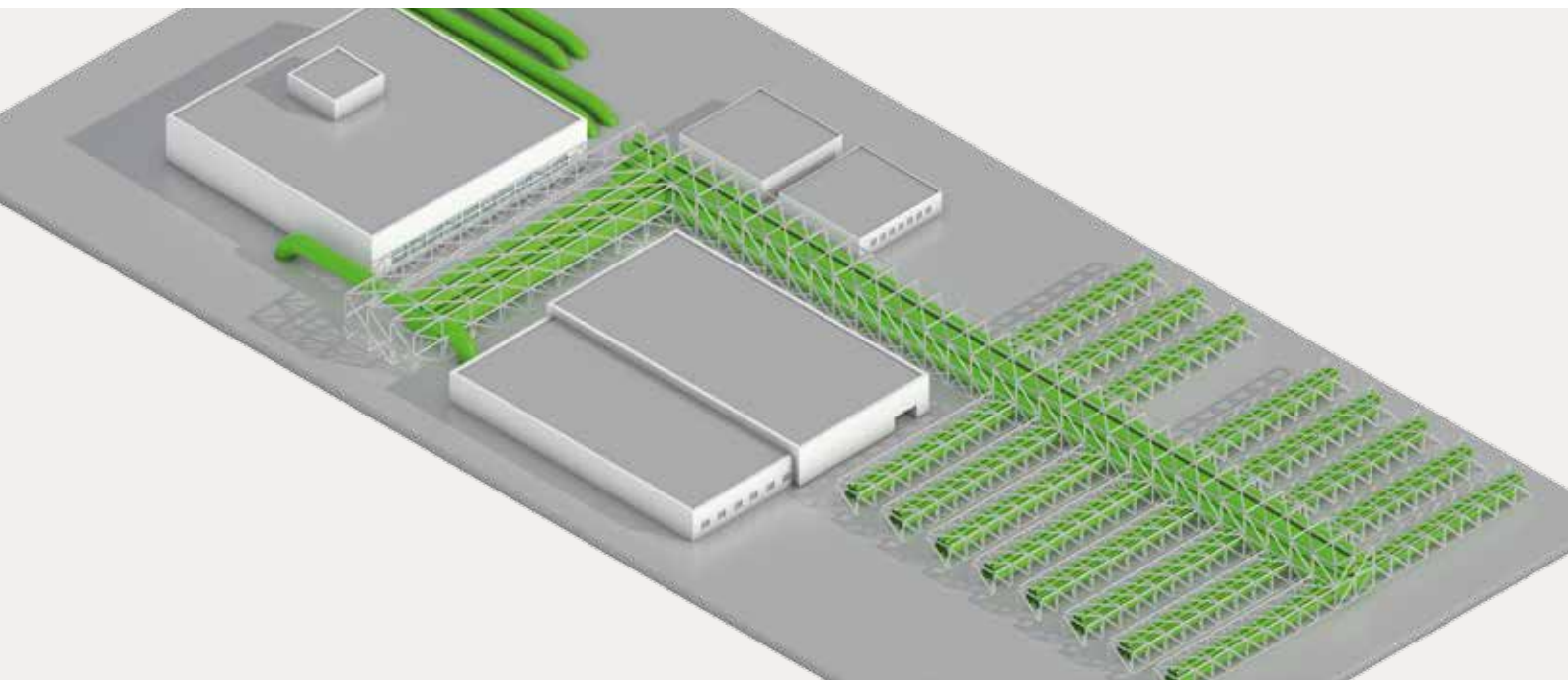

MONITOR YOUR DRIVES

Full Transparency via J1939 Communication

Keep an eye on your generator/drive data with our SAE J1939 protocol-based communication solution. Today, engine efficiency and emission monitoring are essential to all companies using large engines to ship their goods by land or sea.

Monitoring vital engine parameters is more necessary than ever to maximize productivity and minimize a company's overall carbon footprint. WAGO offers a wide range of engine monitoring solutions that help improve overall engine performance. The WAGO-I/O-SYSTEM is a compact, modular and flexible control system that has proven its reliability in many worldwide applications.

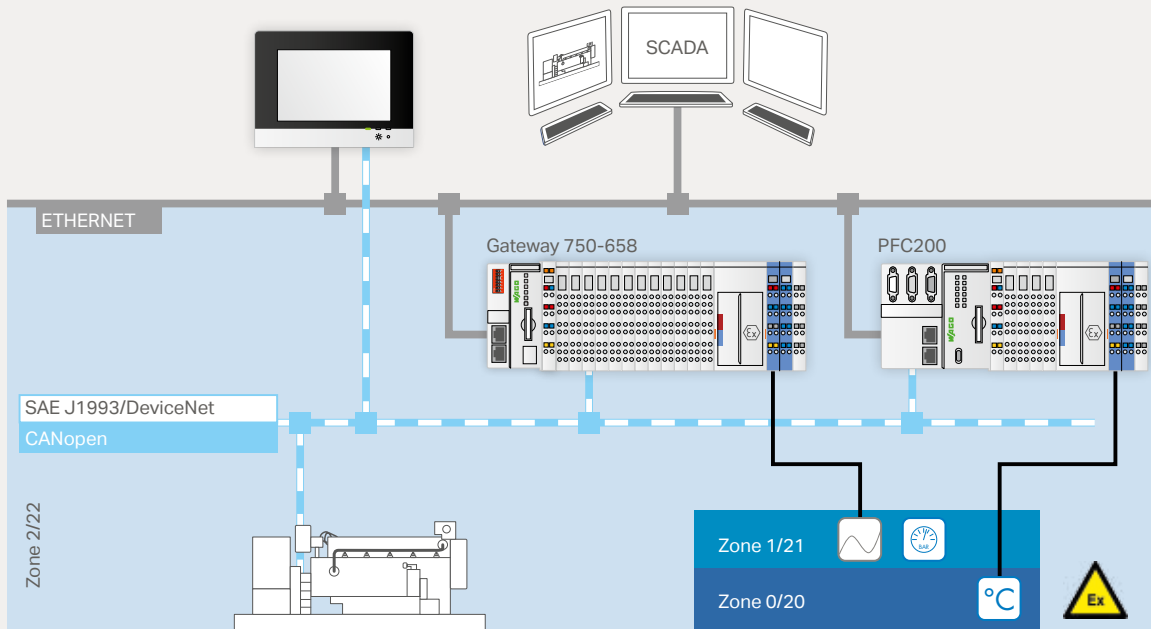

SAE J1939 Protocol Communication via CAN Packages with 29-Bit Header

WAGO offers several J1939 data monitoring technologies via CAN port to increase your application's efficiency. The controller allows you to directly monitor engine information. Using the CAN Gateway (750-658) along with WAGO controllers or fieldbus couplers, you can integrate J1939 data into a higher-level control system/PLC. Prominent interfaces are supported, including:

- Modbus TCP/UDP
- MODBUS RTU
- Serial
- PROFIBUS

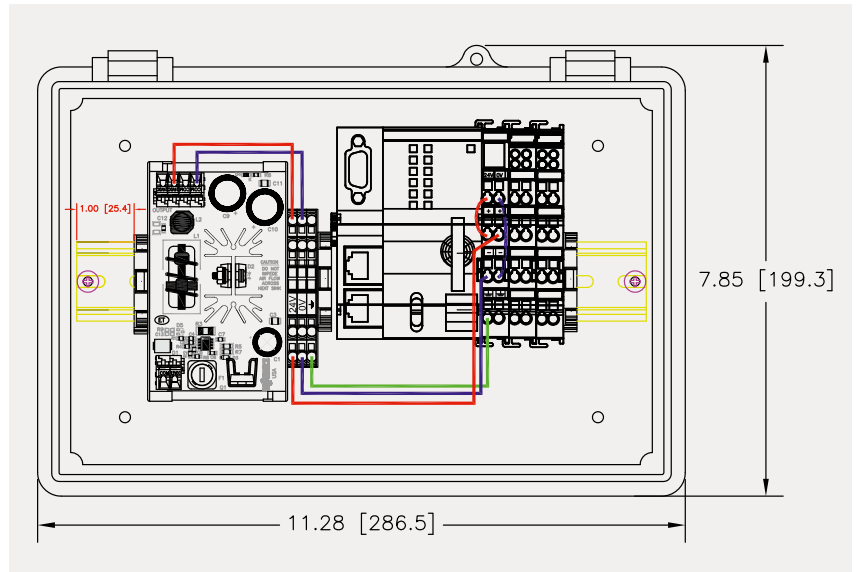

Please contact us and we'll guide you to a custom solution:
process@wago.com



ALARM AND MONITORING SYSTEMS

All Signals in Sight...

Collecting, processing and visualizing data, as well as generating alarms – routine, yet important, tasks that the WAGO-I/O-SYSTEM easily handles.

As an engineering planner, you can implement any conceivable configuration in different network topologies using the modular components of the WAGO-I/O-SYSTEM 750. Whether configuring decentralized intelligence or a central control system with a powerful PLC or using digital and analog signals for valve control or creating light scenarios for a pleasant ambience, our comprehensive automation portfolio lets you create custom solutions.

The *e!COCKPIT* engineering platform supports you throughout your products' life cycles.

Mapping entire topologies and processing multi-controller systems is perfectly compatible with the processing of alarm and monitoring systems with up to 10,000 measuring points. Visualization is based on HTML5 and can be displayed on WAGO displays or on mobile devices.

Topology of a ring-network-based alarm and monitoring system with distribution board:

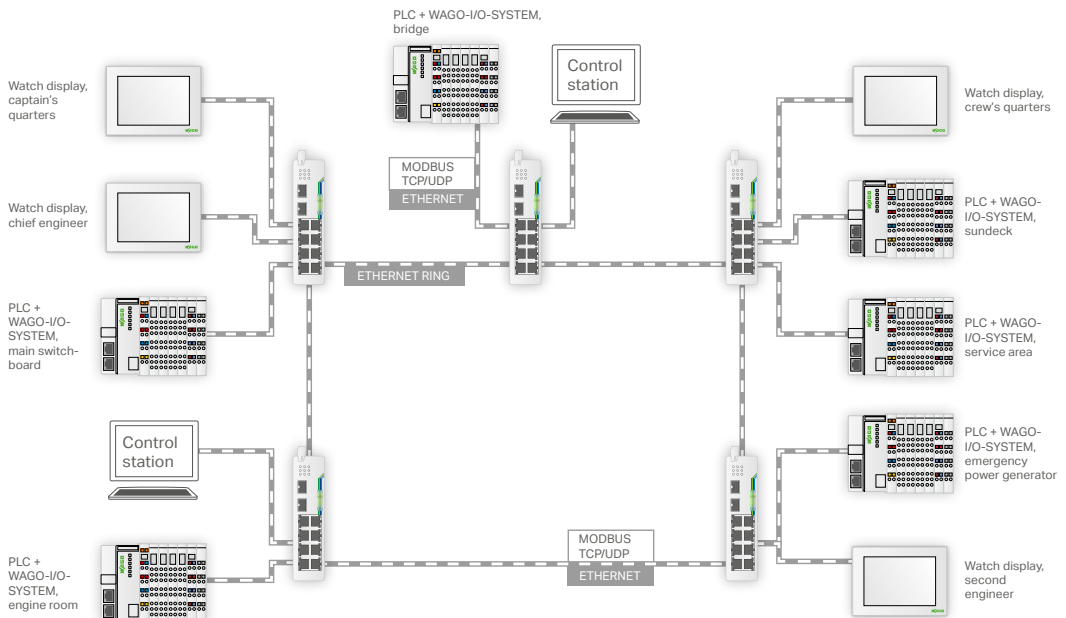

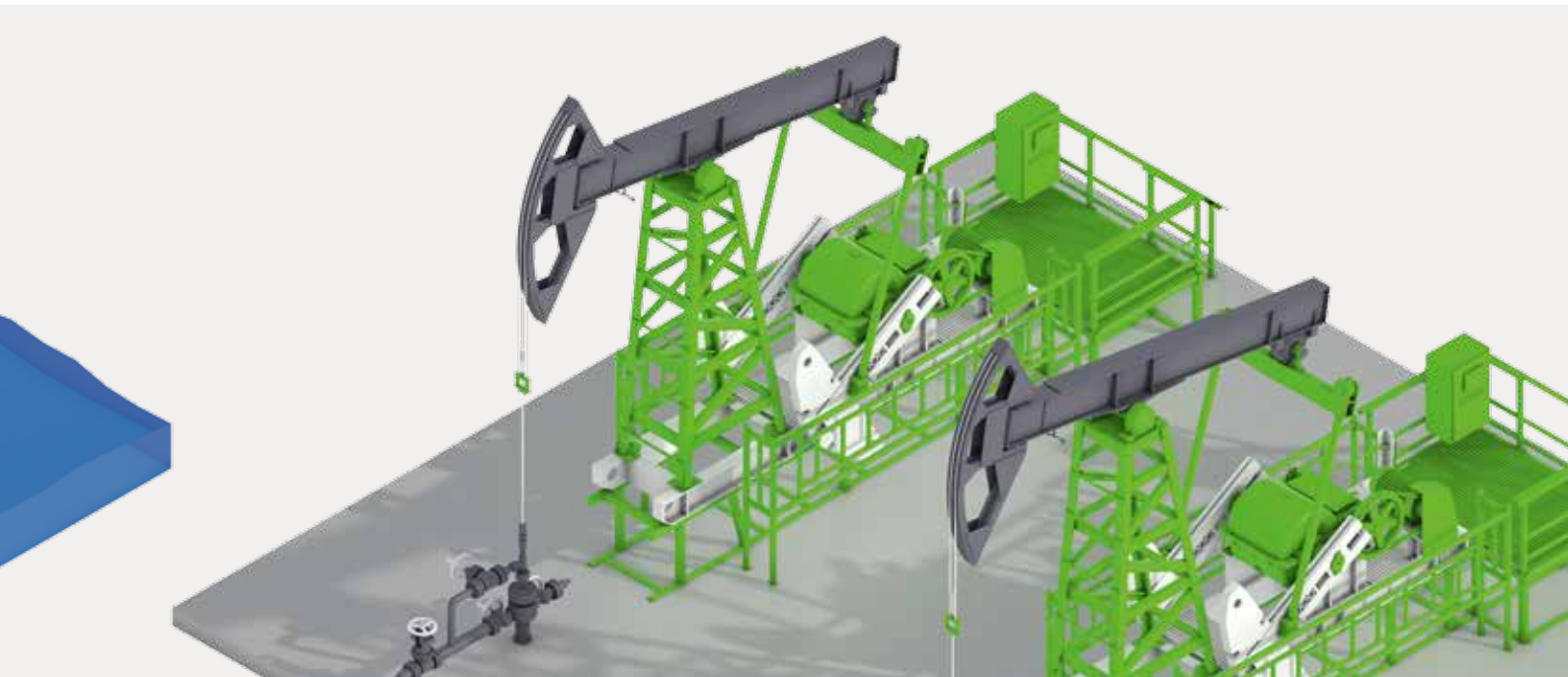

Reliably Increasing Power Supply Availability

Always supply your application safely and reliably – even in the event of a power supply failure. With our redundancy and UPS solutions, you will be ready for anything.

Advantages:

- **Control solution:**
 - Everything from the same trusted source
 - Unmatched system uptime
 - Custom protection in the event of failure
 - High operational reliability via customizable power supply solutions
 - Redundant network and automation levels
- **Power supply solution:**
 - Integrated power diodes with overload capability
 - Solutions for 12/24/48 VDC supply, up to 76 A
 - Parallel-connections possible, reverse voltage protection
 - LED indication and optional signal contact

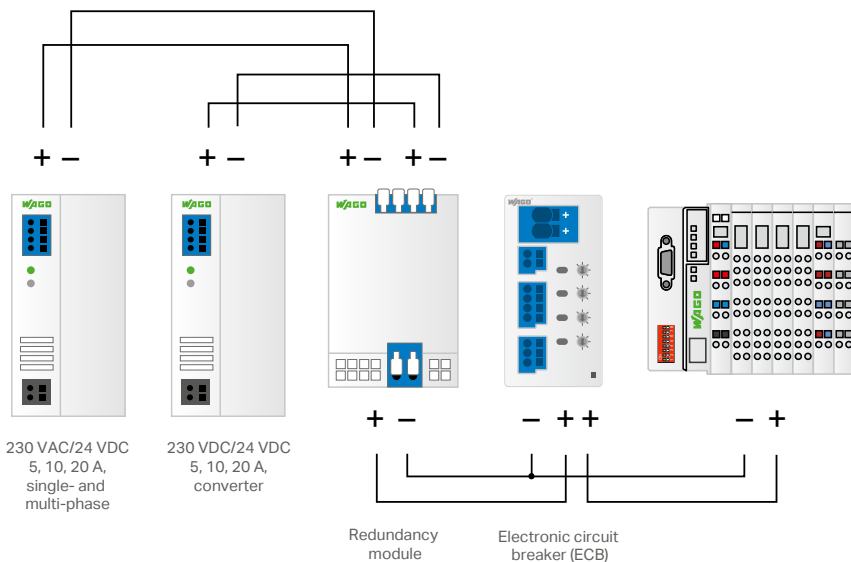



EFFICIENCY THROUGH TRANSPARENCY

Minimize Resource Consumption via Innovative Current and Energy Measurement Technology

Identifying and planning energy consumption is essential to reducing the resources used by your facilities and processes. Typical efficiency measures include:

- Comprehensive network analysis
- Supply line optimization while upgrading systems of the same type
- Transparency in the event of frequency changes and measuring their effects on consumption
- Transparency by switching off consumers (e.g., ventilation)
- Early detection and elimination of asymmetrical network loads (e.g., due to insufficient compensation)
- Identifying and avoiding expensive peak loads via synchronized switch off of secondary consumers
- Long-term changes in energy consumption significantly improve a manufacturer's energy performance certificate rating

WAGO supports you in becoming an EN/ISO 50001 certified company.

To achieve this, we provide you with continuous energy flow monitoring solutions, including: 3-Phase Power Measurement Modules, Current Transformers and/or *JUMPFLEX*® Signal Conditioners.

These components can be easily integrated into existing applications, while providing software-based evaluation, as well as streamlined control and visualization of your systems.

Advantages:

- Products and solutions for energy data acquisition, visualization and evaluation
- Years of proven experience in ISO 50001 energy management system applications – paired with comprehensive power and energy measurement technology solutions

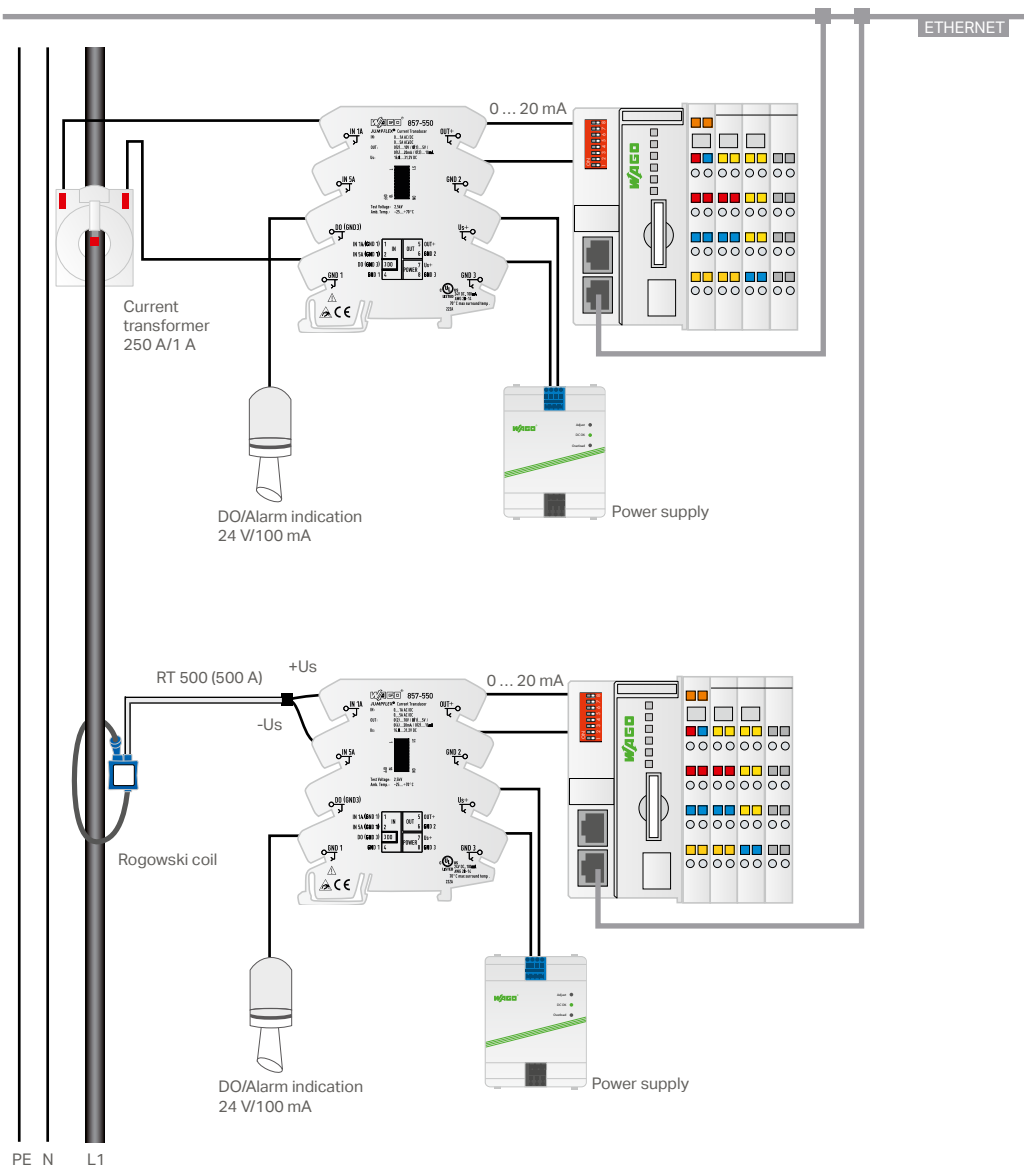

Visualization

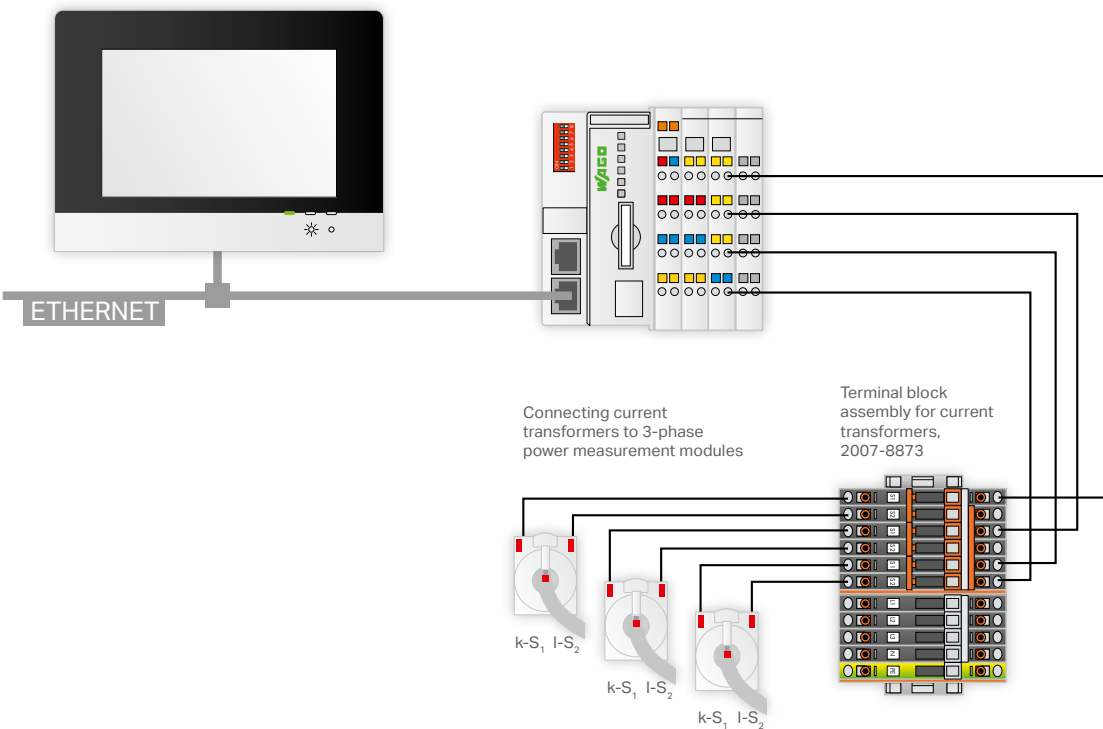

FROM COLLECTOR TO OPTIMIZER

Process Data Collection from WAGO

Increasing Production Efficiency

Today, recording data such as changeover times, down-times and their causes, as well as directly calculating key production figures, is still performed manually. Automated systems provide greater data accuracy and system uptime, while continuously streamlining production processes to increase competitiveness.

Evaluation Criteria

A large number of key efficiency indicators are required in production processes. From the product's weight, shape and appearance to the packaging characteristics and system-specific limitations on through to scheduled retrofitting, cleaning and maintenance times – all data must be recorded for an exact calculation. In fact, only an open, configurable solution can meet this challenge.

We Offer You Custom Solutions Tailored to Your System Requirements

- A distribution cabinet with custom programmed controllers
- Custom parameter settings for every application
- Recording of all relevant signals via optocouplers (e.g., error messages from machines, material shortages, X-ray activation, over/under filling)
- Enter the required information via HMI (e.g., retrofitting, cleaning, maintenance times)
- Display parameters on-site and provide data via Excel export or Web server

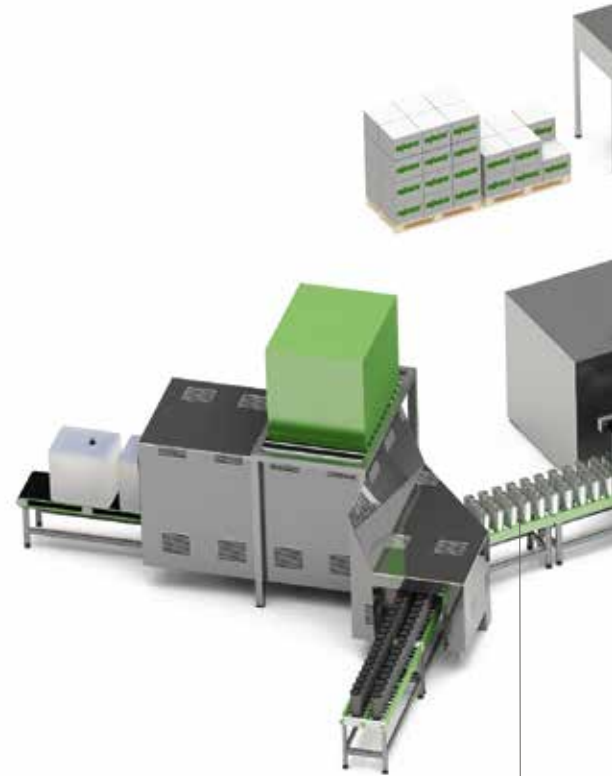

A custom, all-in-one solution from WAGO:
Everything from the same source –
from engineering to programming

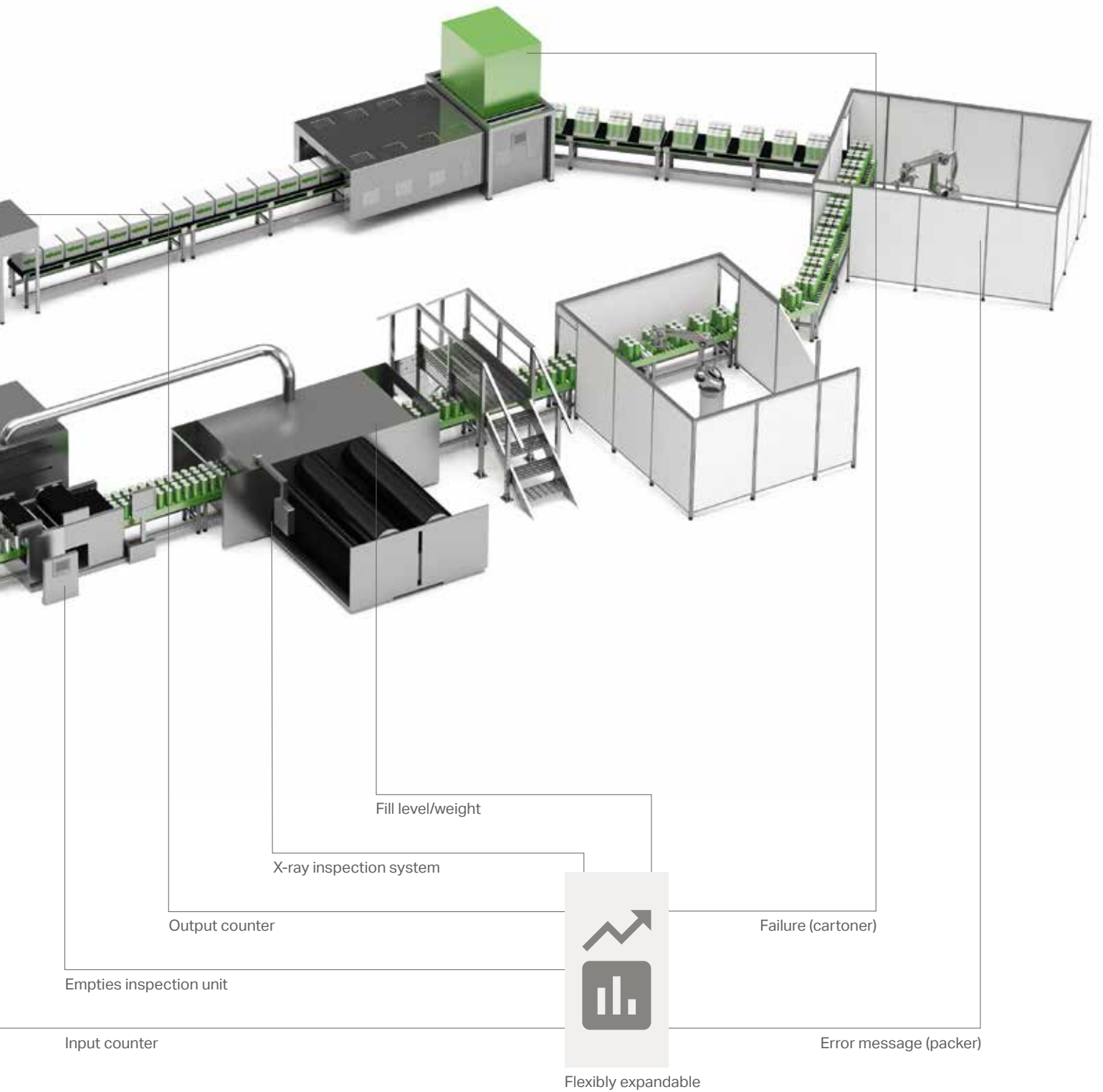

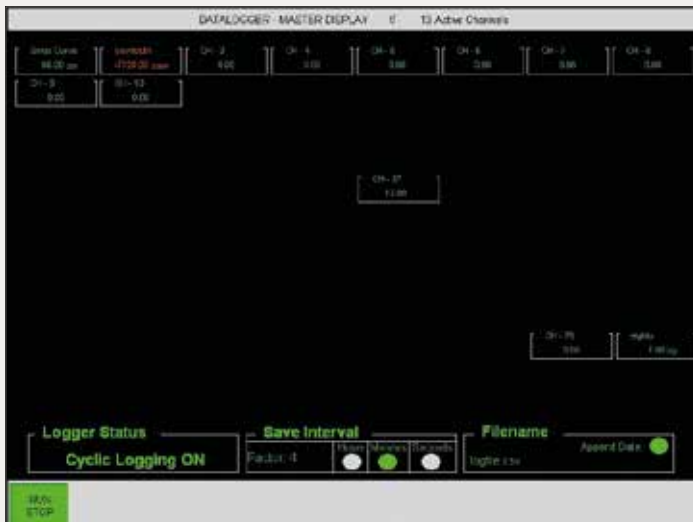

FROM COLLECTOR TO OPTIMIZER

Data Logger

Our data logging solutions allow you track of your production data. In just a few steps, we'll develop a solution for data collection and analysis that meets your specific requirements. From ready-to-use function blocks up to the data logger library, you will find the right components for your solution.

Data logger functionality:

- Poll measurement data and machine states
- Archive data in an open standard format
- Select the storage interval
- Edit both channel designation and unit on demand
- Check measurement data availability either on-site or via the network
- Clearly display all parameters



Advantages:

- Free user application
- Record up to 80 analog/digital channels
- Easy process data collection configuration
- Data storage in open CSV format
- Store process data on removable media (e.g., SD card – depending on hardware)
- Individual expansions and/or program modifications
- Freely adjustable storage interval
- Minimum interval is one second



Data Plotter – The Ideal Complement to a Data Logger

Once data is collected and stored, it can be easily accessed by our data plotter from the application via Web browser.

Data plotter functionality:

- Display multiple measurement data on a time axis
- Freely select the characteristics to be displayed
- A clear overview via simultaneous representation of multiple values
- Easy-to-use, colored channel selection
- Detailed display via zoom function



- Advantages:**
- Free HTML/JavaScript application
 - Easy installation on all PFC controllers
 - Start application from WebVisu via mouse click
 - Read, visualize and interpret data in a CSV format*



SIMPLY CONVENIENT

Ready for MTConnect

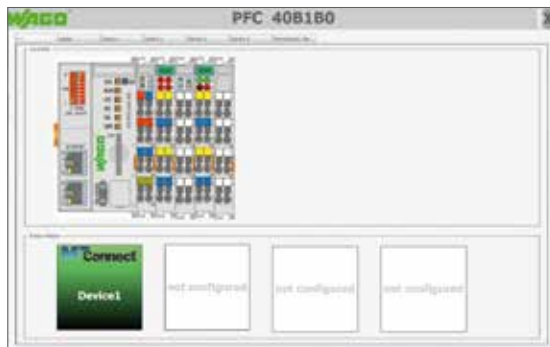

MTConnect – The Standard for Machine Data Collection

- The number one standard from North America
- Simple and robust MDC solution
- Quick configuration via Web-based visualization
- WAGO is a member of the MTConnect Institute

Convenient and Easy Configuration – High Transparency

- MTConnect agent on WAGO's controller (PFC200)
- MTConnect adapter as CODESYS application
- Central adapter configuration via WebVisu
- Adapter and agent can share the same controller (small systems)



Find out more at:
www.mtconnect.org

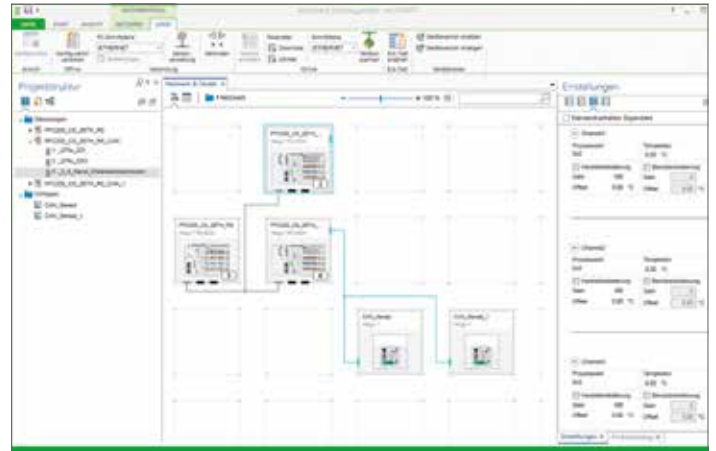
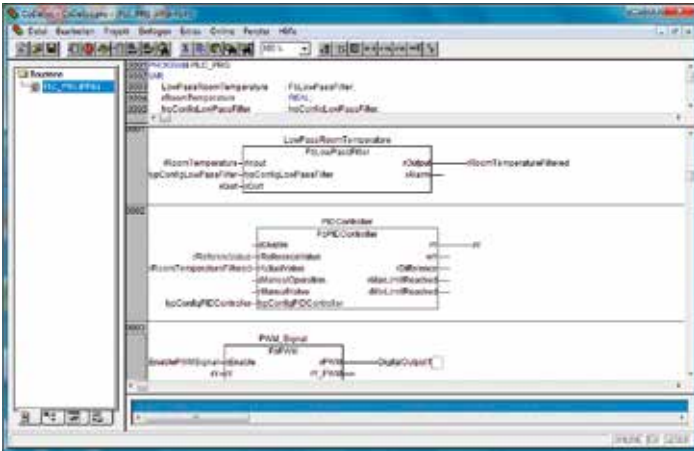

SOFTWARE

Whether Based on CODESYS 2.3 ...

WAGO-I/O-PRO

- CODESYS programming and visualization tool per IEC 61131-3
- IL, SFC, LD, FBD and ST programming languages
- Exchange data with other programs via open interfaces (OPC, DDE)
- Efficiently translate between programming languages
- Automatic variable declaration
- Library management
- Program code with online status indicator
- Offline simulation and integrated process visualization
- Record and graphically display project variables

... or CODESYS 3 – Always the Right Environment

e!COCKPIT

- Minimize development cycles and time to market
- A smart design that invites you to discover
- Expedite your return on investment (ROI)
- Integrated engineering: One software for every task
- Based on CODESYS 3 technology
- Graphical network configuration



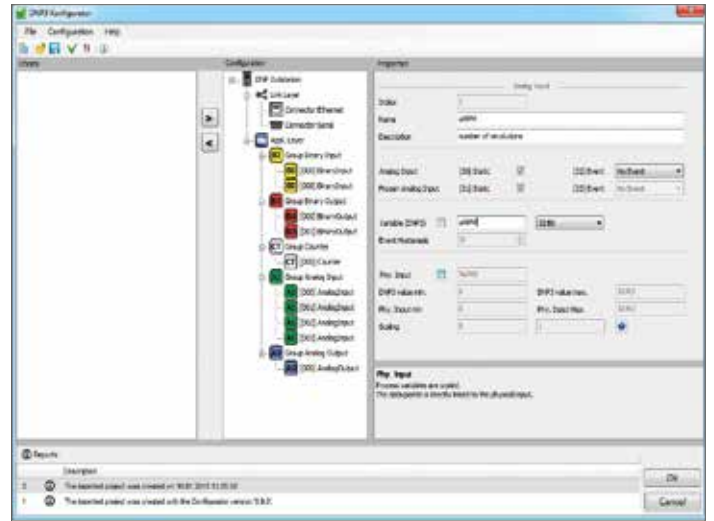
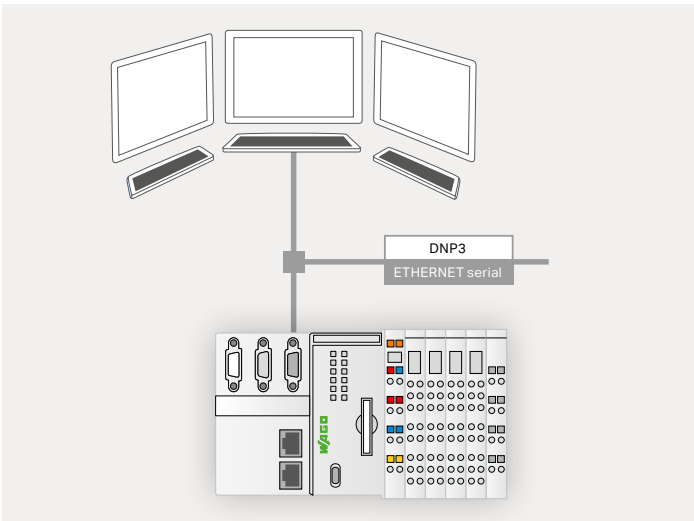

DNP3 Configurator

DNP3 Outstation

- TCP/IP and serial DNP3 communication
- DNP3 level 2 compatibility
- Exchange data with other engineering tools via DNP3 XML device profile format
- Support multiple telecontrol protocols and automate via WAGO's modular I/O-System
- Compatible with WAGO controllers in every performance class
- Simply set DNP3 protocol parameters via CODESYS configurator
- Optionally use PLC functionality via CODESYS
- Support 750 Series I/O Modules

Advantages:

- Configure instead of program
- Signal-oriented IEC 60870 and DNP3
- Object-oriented IEC 61850
- Modbus TCP/RTU

SYSTEM MACROS

Parameter Setting – Not Programming

GENERATION

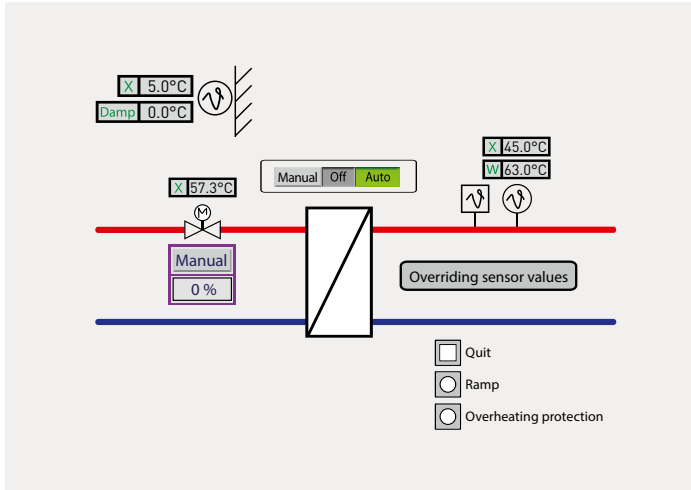

District Heating Transfer Station Macros

- District heating transfer station with supply temperature control and return temperature limitation

DISTRIBUTION

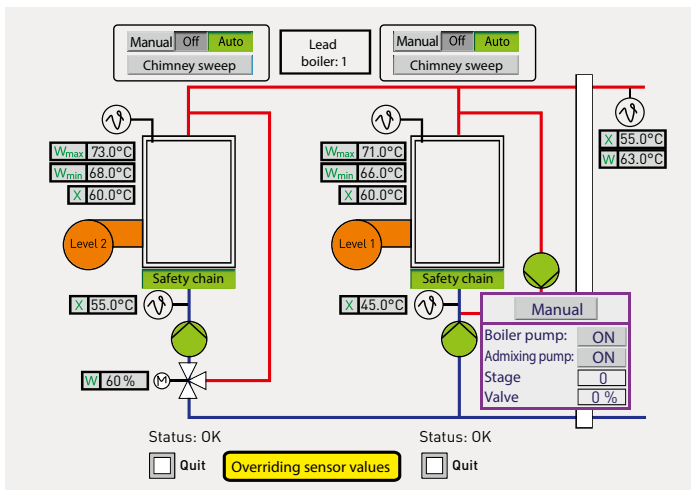

Boiler Macros

- Boiler strategy with two dual-stage boilers
- Boiler strategy with one dual-stage and one modulating boiler

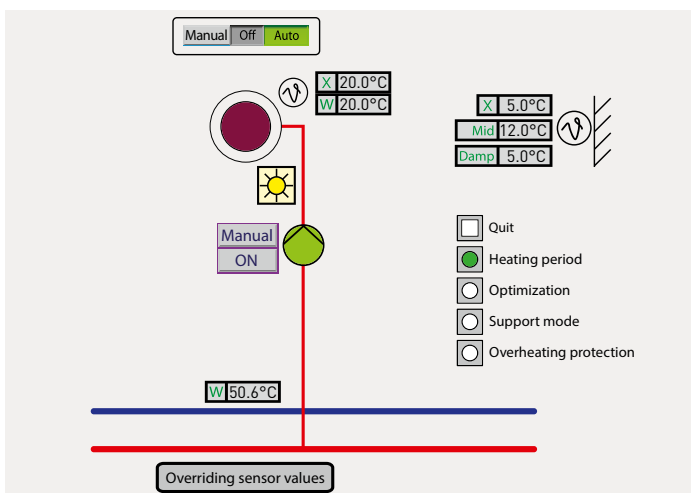

Heating Circuit Macros

- Heating circuit with circulation pump
- Heating circuit with heat exchanger, supply temperature control and return temperature limitation
- Heating circuit with supply temperature control and return temperature limitation

CONSUMPTION

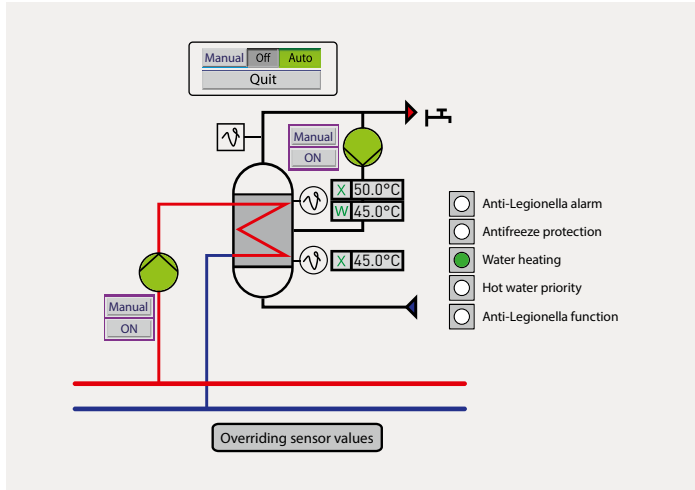

Domestic Water Heating Macros

- Domestic water heating with charging pump
- Domestic hot water production with heat exchanger
- Domestic hot water production with supply temperature monitoring

UTILIZATION

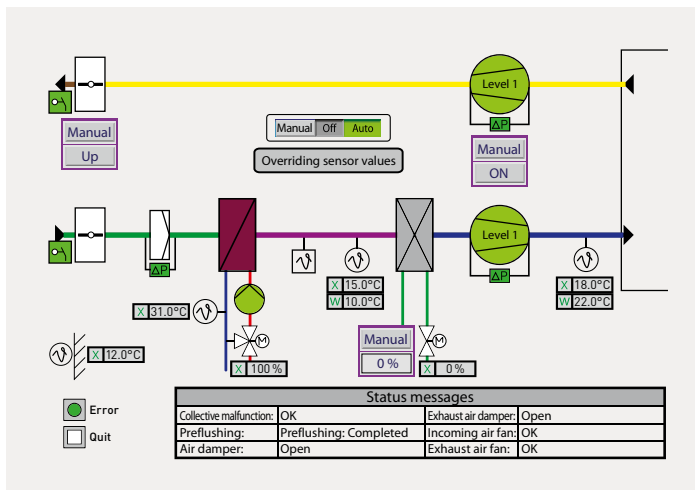

Ventilation Macros

- Supply air temperature control or cascade control
 - Single-stage fan
 - Dual-stage fan
 - Mixed air fan with frequency converter
 - Plate-type heat exchanger
 - Run-around coil system
 - Rotary heat exchanger
- Full air-conditioning system
 - Fan with frequency converter
 - Mixed air humidifying and dehumidifying



Single-Room Control

- PID single-room controller



NOTHING IS AS RELIABLE AS OUR CONNECTIONS

Only the Best Will do!

Our Connections are Made to Last

This applies to both our connection technologies and the customer loyalty we have earned. As the world market leader and inventor of screwless connection technology, we offer the broadest range of rail-mounted terminal blocks with Spring Pressure Connection Technology, covering a wire range between 0.08–185 mm². We can boast that years of experience have proven that our maintenance-free clamping units remain secure – even after 35 years!

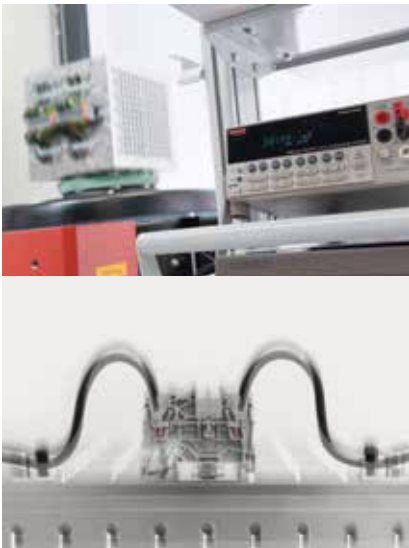

Vibration test



Climatic chamber

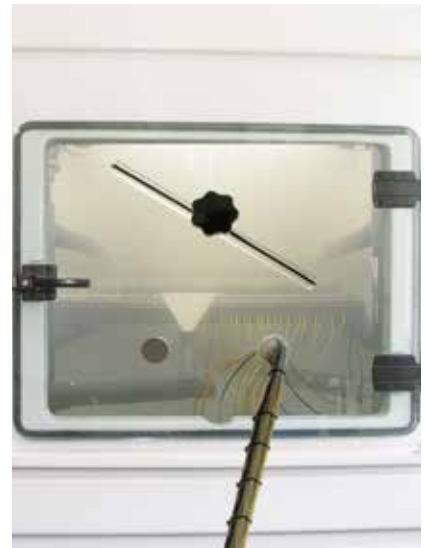

Salt spray test



Proven Quality Thanks to Certified Processes and Products

We don't just promise that our products meet the highest quality demands, you also get this in black and white in the form of internationally recognized certificates. Beyond the requirements outlined by DIN ISO 9001:2000 and ISO 14001, WAGO also fulfills the requirements set forth by all requisite maritime approvals: DNVGL, ABS, LRS, BV, KRS, classNK.



Gastight clamping unit

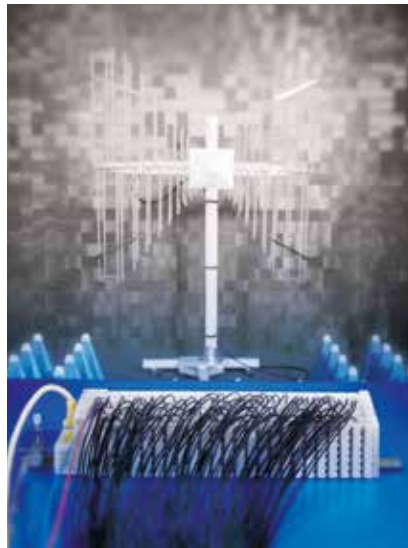

EMC tests



Temperature test



PROVEN AND RELIABLE

Innovation – Quality – Safety

Quality Through Experience and Attention to Detail

- QA is integrated into the manufacturing process
- 100 % testing for proper operation
- In-house, accredited laboratory for internal electrical and mechanical testing on terminal blocks and connectors, as well as for environmental simulation per DIN EN ISO/IEC 17025
- In-house accredited EMC laboratory
- Worldwide Approvals

Proven Quality Thanks to Certified Processes and Products

- DIN ISO 14001:2004 certificate
- DIN EN ISO 50001 energy management certification
- DIN ISO 9001:2008 certificate
- IRIS certificate
- KTA approval for select products



BUNDESAMT FÜR SEESCHIFFFAHRT UND HYDROGRAPHIE



WAGO Kontakttechnik GmbH & Co. KG

Postfach 2880 · 32385 Minden
Hansastraße 27 · 32423 Minden
info@wago.com
www.wago.com

Central controller	+49 571/ 887 - 0
Sales	+49 571/ 887 - 222
Order Service	+49 571/ 887 - 44333
Fax	+49 571/ 887 - 8 44169

WAGO is a registered trademark of WAGO Verwaltungsgesellschaft mbH.

“Copyright – WAGO Kontakttechnik GmbH & Co. KG – All rights reserved. The content and structure of the WAGO websites, catalogs, videos, and other WAGO media are subject to copyright. Distribution or modification to the contents of these pages and videos is prohibited. Furthermore, the content may neither be copied nor made available to third parties for commercial purposes. Also subject to copyright are the images and videos that were made available to WAGO Kontakttechnik GmbH & Co. KG by third parties.”